







# LET'S GRILL.

## FEATURED

- 38" TRL GRILL
- 20" VENTED LIQUID PROPANE TANK OR TRASH DRAWER
- 36" DOUBLE ACCESS DOOR
- 17" TRIPLE DRAWER
- 17" ICE CHEST

## (COVER PHOTO)

- 42" ALTURI GRILL
- 36" 2-DRAWER DRY STORAGE PANTRY & ENCLOSED CABINET COMBO
- 32" OUTDOOR RATED FARMHOUSE SINK





We are a family owned and operated business located in beautiful Huntington Beach, California. We pride ourselves in using only the best materials, and our commitment to quality is reflected in the craftsmanship of the entire Summerset line. With over 20 years of leadership in branding and manufacturing, our core focus is to provide exceptional customer service backed by AMD Direct's Gold Standard Lifetime Warranty.

Summerset Grills strives to meet every outdoor living expression. We offer a wide range of products from grills, refrigeration, sinks, storage solutions, and more. Our goal is to ensure you have everything you need to create your perfect outdoor atmosphere. No matter the style or budget, Summerset will deliver an experience that will help create the ultimate backyard getaway.

# Table of Contents

Grills .....	08
Outdoor Oven .....	22
Gas Griddle .....	24
Side & Power Burners.....	26
Freestanding Carts.....	28
Cold Storage & Sinks.....	34
Outdoor Kitchen Storage .....	42
Grill & Island Accessories .....	52
Indoor/Outdoor Heating.....	64
Warranty .....	70
Contact Information .....	74

**FEATURED**

- 36" ALTURI GRILL
- 33" DOUBLE ACCESS DOOR
- 20" VENTED LIQUID PROPANE TANK OR TRASH DRAWER
- 20" TRASH PULLOUT W/ 10 GALLON TRASH BIN



# Grills

Summerset Grills offers a complete line of commercial grade stainless steel barbecue grills. Whether you're looking for a simple, clean, entry-level grill like the Sizzler, or a entirely Made-in-America, luxury appliance like the Alturi, we have it all.

**FEATURED**

- 38" TRL GRILL
- 15" 3.2C OUTDOOR RATED REFRIGERATOR
- 36" 2-DRAWER & ACCESS DOOR COMBO







## BURNER TYPES

Bringing quality and performance together, our grill lines come equipped with either Stainless Steel Tube Burners, Stainless Steel U-Tube Burners, or Cast Stainless Burners.

## LIGHTING FEATURES

Proper lighting creates drama, style, and function. LED Front Panel Lighting fetches eye-catching flair, while Interior Halogen Lighting provides needed illumination for grilling regardless of the time of day.

## INNOVATIONS

Our grills facilitate outdoor living by providing functional and innovative feature sets, such as rotisserie spit holders, built-in drip trays to keep your area clean and safe, and double-lined hoods for durability and maximum heat retention.

## STAINLESS STEEL CONSTRUCTION

Our grills are made to weather the elements allowing them to remain the centerpiece of your outdoor kitchen. All Summerset grills and accessories feature high-quality stainless steel, providing durability and are backed by the Gold Standard Lifetime Warranty.

## VERSATILITY

Whether it is built-in or freestanding, size (sleek 26" up to spacious 44"), or total BTUs (from 36,000 to 119,000), our grills offer the versatility to maximize every outdoor space. Providing a variety of cooking methods (gas, rotisserie, and infrared) gives you the creative freedom you deserve.





**FEATURED**

- 32" SIZZLER PRO GRILL (TOP LEFT)
- 36" ALTURI GRILL (BOTTOM LEFT)
- 30" RESORT GRILLS (TOP RIGHT)
- GAS TIMER WITH EMERGENCY SHUTOFF
- 27" HORIZONTAL ACCESS DOORS



## ALTURI

The Alturi Series can be summed up in one word: luxury. Designed with elegance, made in the U.S., fueled with power, and loaded with every feature, this grill sets the bar for luxury outdoor cooking. Details like the angle-mounted interior lights, rotisserie storage, and spring-assisted hood provide ultimate convenience, while its #304 stainless steel construction and high BTU burners—the most durable on the market—guarantee lasting performance. When it comes to quality, style, and functionality, Alturi truly stands alone.



#304 Stainless Steel



Double-Lined Hood w/ Spring Assist



Heavy-Duty 9mm Cooking Grates



26,000 BTU #304 Stainless Steel U-Tube Burners



12,000 BTU IR Back Burner



Interior and Exterior Lighting

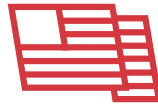

PROUDLY MADE  
IN THE USA

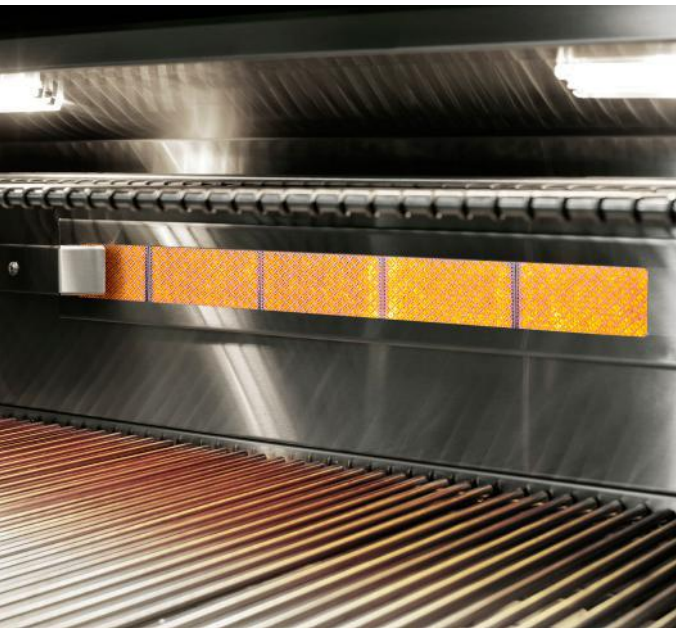

## ADDITIONAL FEATURES

- Interior Halogen Lighting
- Exterior LED Front Panel Lighting
- Heat Zone Separators
- Easy-Clean Briquette System
- Flame Thrower Ignition
- Manual Flash Tube Ignition
- 25 lb. Motor with Rotisserie Kit Included
- 26,000 BTU Drop-In Sear Burner Available
- Matching Sear Side Burner, Double Side Burner, & Power Burner Available
- Red Brass Burners Available
- Grill Cover Included
- Built-In & Cart Models Available
- Built, Factory-Tested, & Serviced in the USA
- Gold Standard Warranty



**30" ALTURI**  
ALT30T-NG / LP

 TOTAL BTU'S: 64,000



**36" ALTURI**  
ALT36T-NG / LP

 TOTAL BTU'S: 90,000



**42" ALTURI**  
ALT42T-NG / LP

 TOTAL BTU'S: 90,000



## TRL/TRL D

The TRL is a fully loaded workhorse, a grilling classic packed with luxury features. Complete with interior lights, exterior LEDs, rear infrared burner, rotisserie kit, flame thrower valves, easy-clean briquette burner covers, and plug-and-play infrared sear zone options, the TRL makes professional grilling easy. With #304 stainless steel exterior construction and 16-gauge stainless steel burners backed by the Gold Standard Lifetime Warranty, this grill is built to last.



#304 Stainless Steel Exterior Construction



Double-Lined Hood



8mm Cooking Grates



18,000 BTU #304 Stainless Burners



15,000 BTU IR Back Burner



Interior and Exterior Lighting

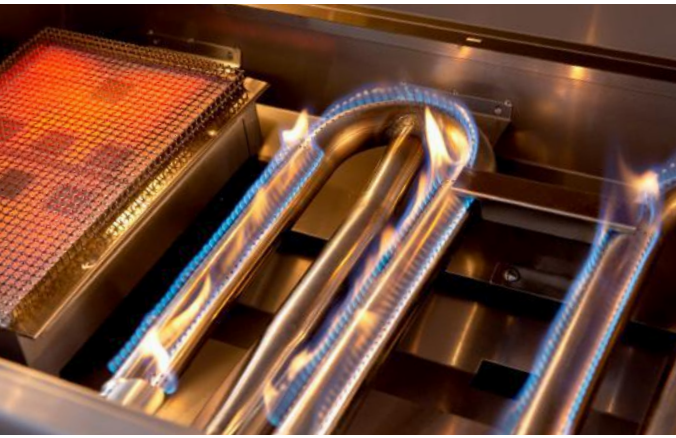

## ADDITIONAL FEATURES

- Interior Halogen Lighting
- Exterior LED Front Panel Lighting
- Heat Zone Separators
- Easy-Clean Briquette System
- Flame Thrower Ignition
- Manual Flash Tube Ignition
- 25 lb. Motor with Rotisserie Kit Included
- 18,000 BTU Drop-In Sear Burner Available
- Matching Sear Side Burner, Double Side Burner, & Power Burner Available
- Built-In & Cart Models Available
- Cast Stainless Burners Available
- Gold Standard Warranty

## TRLD ADDED FEATURES

- Cast Stainless Burners
- Heavy-Duty 9mm Cooking Grates



**32" TRL**  
TRL32-NG / LP

 TOTAL BTU'S: 69,000



**38" TRL**  
TRL38-NG / LP

 TOTAL BTU'S: 87,000



**44" TRL DELUXE**  
TRLD44-NG / LP

 TOTAL BTU'S: 87,000



## SIZZLER PRO

The Sizzler Pro Series combines features, quality construction, and affordability. Based on the same sleek design of our classic Sizzler, with the addition of interior and exterior lighting, 14,000 BTU cast burners and heat zone separators, this grill really sets itself apart. The best part is... it won't break your wallet.



#443 Commercial Grade Stainless Steel



Double-Lined Hood



8mm Cooking Grates



20,000 BTU #201 Cast Stainless Burners



15,000 BTU IR Back Burner



Interior and Exterior Lighting





## ADDITIONAL FEATURES

- Interior Halogen Lighting
- Exterior LED Front Panel Lighting
- Heat Zone Separators
- Easy-Clean Briquette System
- Flame Thrower Ignition
- Manual Flash Tube Ignition
- Rotisserie Kit Available
- Matching Double Side Burner & Power Burner Available
- Side Burner Cart Bracket Available
- Built-In & Cart Models Available
- 14,000 BTU Drop-In Sear Burner Available
- Gold Standard Warranty



**32" SIZZLER PRO**  
SIZPRO32-NG / LP

 TOTAL BTU'S: 71,000



**40" SIZZLER PRO**  
SIZPRO40-NG / LP

 TOTAL BTU'S: 87,000

\*Shown with Optional  
Rotisserie Kit



## SIZZLER

The Sizzler Series is a premium product at an unbeatable price. The streamlined version of the Sizzler Pro, is constructed in all commercial grade stainless steel and designed with careful precision to ensure optimal airflow and even heating. This grill gives its higher-priced competitors a run for their money in both durability and grilling performance, impressing culinary experts and everyday chefs alike.



#443 Commercial Grade Stainless Steel



Double-Lined Hood



8mm Cooking Grates



12,000 BTU #304 Stainless Tube Burners



15,000 BTU IR Back Burner

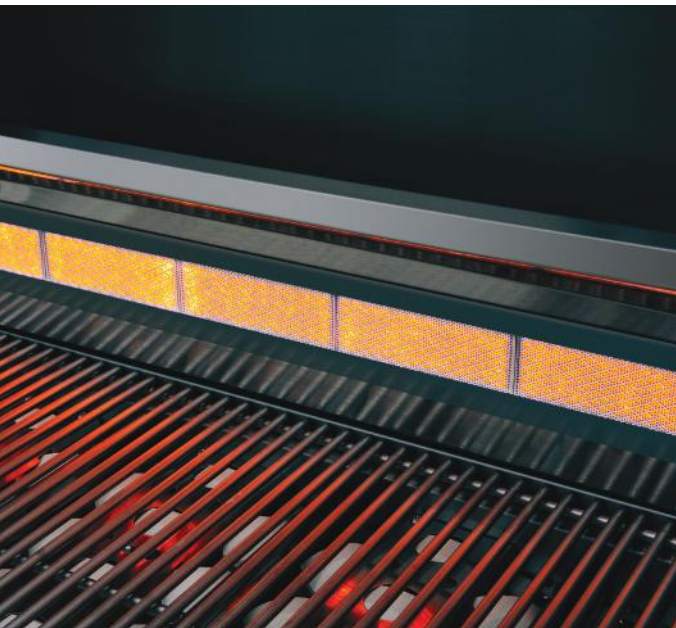

## ADDITIONAL FEATURES

- Easy-Clean Briquette System
- Flame Thrower Ignition
- Manual Flash Tube Ignition
- Rotisserie Kit Available
- Matching Double Side Burner Available
- Side Burner Cart Bracket Available
- Built-In & Cart Models Available
- 12,000 BTU Drop-In Sear Burner Available
- Cast Stainless Burners Available
- Gold Standard Warranty



**26" SIZZLER**  
SIZ26-NG / LP

 TOTAL BTU'S: 36,000



**32" SIZZLER**  
SIZ32-NG / LP

 TOTAL BTU'S: 63,000



**40" SIZZLER**  
SIZ40-NG / LP

 TOTAL BTU'S: 75,000

\*Shown with Optional Rotisserie Kit



## RESORT GRILL

The Summerset Resort Grill has been specially designed to accommodate all types of multi-family and commercial applications. Whether it is an apartment community, hotel, or country club, these environments get a great deal of extra use. Donning the same beefed-up body as our luxury Alturi series, the Resort Grill is made with Commercial Grade stainless steel construction, 9mm cooking grates, and extra thick 14-gauge stainless steel flame tamers. Available in built-in, cart, and pedestal models, this grill is the perfect option for any commercial application.



#304 Stainless Steel



Double-Lined Hood



Heavy-Duty 9mm Cooking Grates



26,000 BTU #304 Stainless U-Tube Burners



Flame Thrower Ignition



PROUDLY MADE  
IN THE USA

## ADDITIONAL FEATURES

- Heavy-Duty 14-Gauge Flame Tamers
- Locking Drip Tray
- Heavy-Duty Anti-Theft Knobs
- LP Conversion Kit Included
- Built-In, Cart, and Pedestal Models Available
- Timer and Timer Panel Sold Separately
- Built, Factory Tested, and Serviced in the USA
- Gold Standard Warranty



**30" RESORT GRILL**  
SBG30-NG / LP

 **TOTAL BTU'S: 52,000**

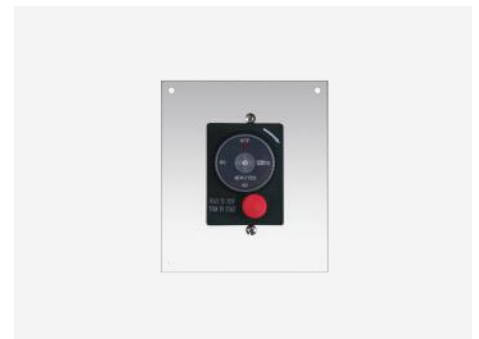

**GAS TIMER WITH EMERGENCY  
SHUTOFF / MOUNTING PLATE**  
ESTOP1-0H

\*Mounting Plate Sold Separately (TIMER-IVC-PANEL)

# Gas Griddle

Explore new flavors with the all-new, premium 30" Gas Griddle by Summerset. Constructed of #304 stainless steel, this heavy-duty flat top grill is the perfect addition to your outdoor kitchen, diversifying your menu, and adding a host of new flavors. The expansive, 495-square-inch cooking surface is made of half-inch thick steel, powered by two 18,000 BTU U-Tube burners below. The combined 36,000 BTUs of power guaranty searing heat, perfect for steaks, burgers, carne asada, eggs, pancakes, and more. Blue LEDs illuminate the front panel, while the full-size #304 stainless steel cover ensures your griddle plate is protected from the elements and always ready for the next meal. Fire up the Gas Griddle by Summerset and take your culinary experiences to new heights.

- #304 Stainless Steel Construction
- 1/2" thick Stainless Steel Cooking Surface
- 495 Sq. Inches of Cooking Surface
- 18,000 BTU Stainless Steel U-Tube Burners
- 36,000 Total BTU Output
- Included #304 Stainless Steel, Removable Lid
- Large Capacity Drip Tray
- Blue Exterior LED Lighting
- High-Power, Reliable Flame Thrower Ignition
- Grill Liner Available - GL-GRID30
- Overall Dimensions: 30" W x 28" D x 12" H
- Weight: 120 LB.
- CSA Certified
- Gold Standard Warranty

**NEW PRODUCT!**



## 30" GAS GRIDDLE

GRID30-NG / GRID30-LP

 TOTAL BTU'S: 36,000





# Outdoor Oven

From appetizers to desserts, this oven will bake it all. Now you can add pizzas, roasts, brownies and more to your outdoor menu. To top it off, its #304 stainless steel construction is sure to outlast the competition.

- Built-In Halogen Cooking Light
- Large Oven Capacity; Cook up to a 16-Inch Pizza
- Utensil Drawer
- Convenient Electronic Ignition
- Full View Front Window with Temperature Gauge
- Cool Touch, Heat Resistant Handle
- Flange Kit Available for Built-In Models
- CSA Certified
- Available in NG and LP
- Includes Deluxe Freestanding or Built-in Cover (GRILLCOV-OVBI / CARTCOV-OVFS)
- Gold Standard Warranty



## OUTDOOR OVEN

SS-OVBI-NG / LP

 TOTAL BTU: 20,000



## OUTDOOR OVEN WITH CART

SS-OVFS-NG / LP

 BTU: 16,000



#304 Stainless Steel



Double-Lined Hood



3 Cooking Racks



20,000 BTU #304 Stainless Steel Burner



Pizza Stone & Wood Chip Smoker Box Included



Optional Pizza Accessory Kit (SSTOAK-1)





\*Shown with Hidden Utensil Drawer

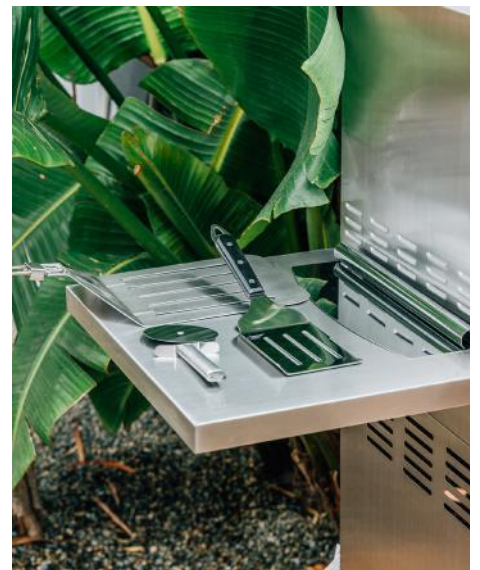

\*Some Items from Optional Pizza Accessory Kit Shown

# Side & Power Burners

Here we've combined the comfort of an indoor kitchen range with all the benefits of being outside. Specially designed for performance and function, a Summerset side burner is the perfect addition to your outdoor kitchen. Commonly used for finish cooking, sauces, or heating foods that require lower, more controlled temperatures than your grill, a side burner offers the convenience of range top cooking and grilling simultaneously. Find the perfect side burner for your outdoor kitchen with four professional lines to choose from: Sizzler, Sizzler Pro, TRL and Alturi. All Summerset side burners feature stainless steel construction, heavy duty stainless steel grates, and up to 60,000 BTUs of power—all packed in a sleek design and backed by AMD Direct's Gold Standard Lifetime Warranty.



**FEATURED**  
- ALTURI POWER BURNER



- ALTURI POWER BURNER**  
ALTPB2-NG / LP
- Total BTU's: 60,000
  - Inner Round Brass Burner, Outer Tube Stainless Burner
  - Cooking Surface: 20" x 20"
  - Front Panel LED Lighting
  - Protective Lid included
  - Made in the USA



- ALTURI LIGHTED DOUBLE SIDE BURNER**  
ALTSB2-NG / LP
- Total BTUs: 35,000
  - Round Brass Burners
  - Cooking Surface: 21½ x 11½
  - Front Panel LED Lighting
  - Protective Lid included
  - Made in USA

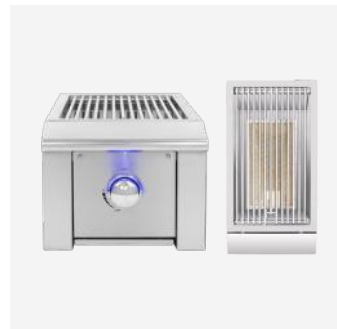

- ALTURI LIGHTED SEAR SIDE BURNER**  
ALTSS-NG / LP
- Total BTUs: 26,000
  - Infrared Burner (Up to 1600°F)
  - Adjustable High/Low Technology
  - Cooking Surface: 21¼ x 11½
  - Front Panel LED Lighting
  - Protective Lid included
  - Made in USA



- SINGLE SIDE BURNER**  
SSSB1-NG / LP
- Total BTUs: 15,000
  - Cooking Surface: 9½ x 9½
  - Protective Lid included
  - Round Brass Burner

\*Side Burners available in Natural Gas (NG) or Liquid Propane (LP)



**TRL LIGHTED POWER BURNER**

TRLPB2-NG / LP

- Total BTUs: 60,000
- Cooking Surface: 13½ x 17¼
- Inner Round Brass Burner, Outer Tube Stainless Burner
- Removable Center Grate for Wok Cooking
- Front Panel LED Lighting



**TRL LIGHTED DOUBLE SIDE BURNER**

TRLSB2-NG / LP

- Total BTUs: 30,000
- Round Brass Burners
- Cooking Surface: 19¼ x 11¼
- Front Panel LED Lighting



**TRL SEAR SIDE BURNER**

TRLSS-NG / LP

- Total BTUs: 15,000
- Cooking Surface 18-1/2" x 11-1/2"
- Infrared Burner (Up to 1600F)

**NEW PRODUCT!**



**SIZZLER PRO POWER BURNER**

SIZPROP-NG / LP

- Total BTUs: 60,000
- Inner Round Brass Burner, Outer Tube Stainless Burner
- Cooking Surface: 13 1/2 x 17 1/4



**SIZZLER PRO LIGHTED DOUBLE SIDE BURNER**

SIZPROSB2-NG / LP

- Total BTUs: 24,000
- Cooking Surface: 19¼ x 10¼
- Front Panel LED Lighting
- Round Brass Burners

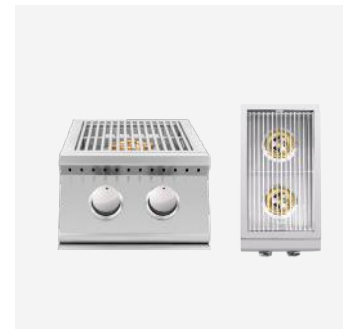

**SIZZLER DOUBLE SIDE BURNER**

SIZSB2-NG / LP

- Total BTUs: 24,000
- Cooking Surface: 19½ x 10½
- Round Brass Burners



**FEATURED**  
- SIZZLER PRO  
DOUBLE SIDE  
BURNER

# Freestanding Carts

Summerset Professional Grills' complete line of grill carts offer a premium alternative to built-in models. Constructed of the highest quality stainless steel and manufactured in the USA, Summerset's durable carts offers stability, storage and convenience for casual and professional chefs alike.

**FEATURED**

- 38" TRL GRILL
- 38" TRL DELUXE CART





## FREESTANDING CARTS



### SUMMERSET SIZZLER CART

CART-SIZ26 / CART-SIZ32 / CART-40

- Commercial Grade Stainless Steel
- Magnetic Double Access Door
- Front Locking Caster Wheels
- Interior Paper Towel Holder
- Propane Tank Storage
- Side, Rear and Bottom Ventilation
- Made in America



### SUMMERSET SIZZLER DELUXE CART

CART-SIZ32-DC / CART-SIZ40-DC

- Commercial Grade Stainless Steel
- Magnetic Access Door with 2-Drawer Storage
- Front Locking Caster Wheels
- Interior Paper Towel Holder
- Propane Tank Storage
- Side, Rear and Bottom Ventilation
- Fully Assembled
- Made in America



### SUMMERSET TRL CART

CART-TRL32 / CART-TRL38

- Commercial Grade Stainless Steel
- Magnetic Double Access Door
- Front Locking Caster Wheels
- Interior Paper Towel Holder
- Propane Tank Storage
- Side, Rear and Bottom Ventilation
- Made in America



### SUMMERSET TRL DELUXE CART

CART-TRL32-DC / CART-TRL38-DC /  
CART-TRLD44-DC

- Commercial Grade Stainless Steel
- Magnetic Access Door with 2-Drawer Storage
- Front Locking Caster Wheels
- Interior Paper Towel Holder
- Propane Tank Storage
- Side, Rear and Bottom Ventilation
- Fully Assembled
- Made in America



**FEATURED**  
- SIZZLER DELUXE CART

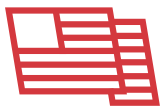

PROUDLY MADE  
IN THE USA





FEATURED - ALTURI 42" CART



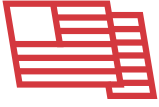

PROUDLY MADE  
IN THE USA

## FREESTANDING CARTS (CONT.)



### SUMMERSET RESORT PEDESTAL

SBG30-PED

- Commercial Grade Stainless Steel
- Locking Double Door
- Propane Tank Storage
- Side, Rear and Bottom Ventilation
- Fully Assembled
- Also Available with Wheels (CART-ALT30)
- Timer Available
- Made in America



### SUMMERSET RESORT CART

CART-ALT30

- Commercial Grade Stainless Steel
- Magnetic Double Door Access
- Locking Caster Wheels
- Interior Door Condiment Tray
- Propane Tank Storage
- Side, Rear and Bottom Ventilation
- Fully Assembled
- Made in America



### SUMMERSET ALTURI 30" CART

CART-ALT30

- Commercial Grade Stainless Steel
- Magnetic Double Door Access
- Locking Caster Wheels
- Interior Door Condiment Tray
- Propane Tank Storage
- Side, Rear and Bottom Ventilation
- Fully Assembled
- Made in America



### SUMMERSET ALTURI 36" & 42" CART

CART-ALT36 / CART-ALT42

- Commercial Grade Stainless Steel
- Magnetic Access Door with 2-Drawer Storage
- Locking Caster Wheels
- Interior Door Condiment Tray
- Propane Tank Storage
- Side, Rear and Bottom Ventilation
- 30" Model Features Double Access Doors
- Fully Assembled
- Made in America

# Cold Storage & Sinks

Enjoy fresh ingredients and chilled beverages with our full line of cold storage products. All refrigeration offers durable construction for the outdoors, temperature control, adjustable legs for leveling, and sleek design for function and beauty. Bring the sophistication of your indoor refrigeration systems outside with matching performance and design.

**FEATURED**

- 24" 5.3C DELUXE OUTDOOR RATED REFRIGERATOR LEFT DOOR
- 24" 5.3C DELUXE OUTDOOR RATED REFRIGERATOR RIGHT DOOR





## 21" REFRIGERATION SERIES

The 21" Compact Refrigerator Series offers 4.2 cubic feet of storage, reversible #304 stainless steel doors, and automatic interior lighting. Build them into an island or use them inside—these refrigerators will add a whole new level of convenience to your setup.



### 21" 4.2C COMPACT REFRIGERATOR

SSRFR-21S / SSRFR-21S-R

- Reversible Door Capability
- 32° - 50° Temperature Range



### 21" 4.2C DELUXE COMPACT REFRIGERATOR

SSRFR-21D / SSRFR-21D-R

- Left and Right Doors Available
- 32° - 50° Temperature Range

#### FEATURES:

- #304 Stainless Steel Door Construction
- Storage Capacity: 4.2 ft<sup>3</sup>
- Locking Doors
- Manual Temperature Controller
- Built-In Design
- Rear Venting
- Commercial & Residential Compliant



#### FEATURED

- 21" COMPACT REFRIGERATOR (LEFT) - 24" OUTDOOR RATED REFRIGERATOR (RIGHT)

# OUTDOOR REFRIGERATION

We offer a wide variety of luxury stainless steel refrigerators. From 3.2 to 6.6 cubic feet of storage, these appliances will help keep your food fresh, wine chilled, and beer cold, bringing the function of your indoor refrigeration outside to join the party.



## 24" 5.3C OUTDOOR RATED REFRIGERATOR

SSRFR-24S / SSRFR-24S-R

- Storage Capacity: 5.3 ft<sup>3</sup>
- 32° - 50° Temperature Range



## 24" 5.3C DELUXE OUTDOOR RATED REFRIGERATOR

SSRFR-24D / SSRFR-24D-R

- Storage Capacity: 5.3 ft<sup>3</sup>
- 32° - 50° Temperature Range

- FEATURES:**
- #304 Stainless Steel Door Construction
  - UL Rated for Outdoor Use
  - Locking Doors
  - Front Venting
  - Left and Right Doors Available
  - Auto-Defrost
  - Electronic Temperature Controller w/ Digital Display
  - Built-In Design
  - Commercial & Residential Compliant



## 24" 5.3C DELUXE OUTDOOR RATED 2-DRAWER REFRIGERATOR

SSRFR-24DR2

- Storage Capacity: 5.3 ft<sup>3</sup>
- Two Soft-Close Drawers
- 32° - 50° Temperature Range



## 15" 3.2C OUTDOOR RATED REFRIGERATOR

SSRFR-15S

- Storage Capacity: 3.2 ft<sup>3</sup>
- 32° - 50° Temperature Range



## 15" 3.2C OUTDOOR RATED REFRIGERATOR WITH GLASS DOOR

SSRFR-15G

- Storage Capacity: 3.2 ft<sup>3</sup>
- 32° - 50° Temperature Range
- Tinted Glass

## KEGERATORS



### 24" 6.6C DELUXE OUTDOOR RATED KEGERATOR (NO TAP / SINGLE TAP / DOUBLE TAP)

SSRFR-24DK / SSRFR-24DK1 / SSRFR-24DK2

- Storage Capacity: 6.6 ft<sup>3</sup>
- Top Guard Rail Sold Separately
- Available in Single or Double Tap Towers
- 32° - 50° Temperature Range



### SINGLE KEG TAP FOR KEGERATOR

SSRFR-TAP-1

- Fits SSRFR-24DK
- Includes Tap Tray, Single Hose, CO2 Kit (Tank & Regulator)



### DOUBLE KEG TAP FOR KEGERATOR

SSRFR-TAP-2

- Fits SSRFR-24DK
- Includes Tap Tray, Two Hoses, CO2 Kit (Tank & Regulator)



## ICE MAKERS



### 50 LB. DELUXE OUTDOOR RATED ICE MAKER W/ GRAVITY DRAIN

SSIM-15

- Daily Ice Output: 50 lbs.
- Storage Capacity: 25 lbs.
- Gravity Drain
- Temperature Control Not Necessary

## WINE COOLERS



### 24" 5.3C DELUXE OUTDOOR RATED SINGLE ZONE WINE COOLER

SSRFR-24W

- Storage Capacity: 5.3 ft3
- 46 Bottle Capacity
- Tinted Glass
- Anti-Vibration System
- Temperature Range: 41° - 64°



### 24" 5.3C DELUXE OUTDOOR RATED DUAL ZONE WINE COOLER

SSRFR-24WD

- Storage Capacity: 5.3 ft3
- 46 Bottle Capacity
- Tinted Glass
- Anti-Vibration System
- Upper Temperature Range: 41° - 50°
- Lower Temperature Range: 50° - 64°



### 15" 3.2C OUTDOOR RATED SINGLE ZONE WINE COOLER

SSRFR-15W

- 28 Bottle Capacity
- Anti-Vibration System
- 41° - 64° Temperature Range
- Tinted Glass



### 15" 3.2C OUTDOOR RATED DUAL ZONE WINE COOLER

SSRFR-15WD

- Storage Capacity: 3.2 ft3
- 20 Bottle Capacity
- Tinted Glass
- Anti-Vibration System
- Upper Temperature Range: 41° - 50°
- Lower Temperature Range: 50° - 64°

## SINKS AND BAR PREP

Take your outdoor kitchen to the next level with our Beverage Center and selection of drop-in sinks. Complete with an ice compartment, sink, towel holder, speed rail with condiment tray, and built-in bottle opener, the Beverage Center will make you the best host in the neighborhood. Don't worry, when the sun goes down the LEDs will light it up and keep the party going!



**15" DROP-IN SINK &  
HOT/COLD FAUCET**  
SSNK-15D



**19" UNDERMOUNT SINK &  
360° HOT/COLD FAUCET**  
SSNK-19U



**FARMHOUSE SINK**  
SSNK-32FH  
\*Faucet Sold Separately



**30" LIGHTED BEVERAGE &  
PREP STATION**  
SSBC-30L





**FEATURED**

- 19" UNDERMOUNT SINK & FAUCET

## ICE CHESTS

With our grills heating things up, we have just what you need to keep cool. Choose between two sizes to optimize your serving station. With up to 40 lbs. of ice capacity, load them up with refreshments, snacks, or ingredients to make for a good time.



**17" 1.7C DROP-IN COOLER  
(20LB ICE CAPACITY)**

SSIC-17



**28" 2.7C DROP-IN COOLER  
(40LB ICE CAPACITY)**

SSIC-28

# Outdoor Kitchen Storage

Our full line of outdoor kitchen storage features a heavy-duty flange and soft closing drawers. Double-lined construction provides the extra insulation and resilience needed against the elements, and a thicker flange provides a sturdy, seamless fit and elegant style that will work with any countertop and island finish. Soft closures bring the luxury of an indoor kitchen to the outdoor space. Our components also feature #304 stainless steel construction, magnetic latches, smooth gliding drawers on heavy-duty tracks, and a Gold Standard Lifetime Warranty. Plus, all access doors feature reversible door mounting to meet your specific needs. Sleek and intuitive, our components provide an integrated solution that can be personalized to any space.

## FEATURED

- 17" DOUBLE DRAWER
- 36" DOUBLE ACCESS DOOR
- 24" 5.3C DELUXE OUTDOOR RATED 2-DRAWER REFRIGERATOR





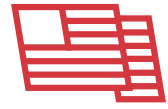

PROUDLY MADE  
IN THE USA

## ACCESS DOORS

Our access doors give you elegant and convenient access to your island, utilities, and grill. Made with #304 stainless steel, heavy-duty flanges, reversible door mounting, and magnetic latches.



**33" VENTED DOUBLE ACCESS DOOR**

SSDD-33V

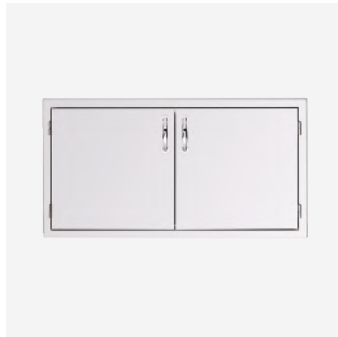

**DOUBLE ACCESS DOOR  
(26", 30", 33", 36", 39", 42", 45")**

SSDD-26 / SSDD-30 / SSDD-33  
SSDD-36 / SSDD-39 / SSDD-42  
SSDD-45



**VERTICAL ACCESS DOOR  
(16", 18", 20")**

SSDV-16 / SSDV-18 / SSDV-20

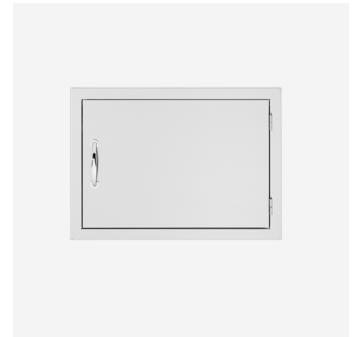

**HORIZONTAL ACCESS DOOR  
(22", 27")**

SSDH-22 / SSDH-27

## DOOR/DRAWER COMBOS

These components are specifically designed with versatility in mind. Whether you need a simple storage setup, LP tank drawer, paper towel holder, or weather-resistant dry storage shelving, these #304 stainless steel combos give you the options you need for a perfect outdoor setup.



**2-DRAWER & ACCESS DOOR COMBO (30", 33", 36", 42")**

SSDC2-30 / SSDC2-33  
SSDC2-36 / SSDC2-42



**33" 3-DRAWER & ACCESS DOOR COMBO**

SSDC3-33



**33" 2-DRAWER & LP TANK PULLOUT DRAWER COMBO**

SSDC2-33LP



**17" VERTICAL 2-DRAWER & PAPER TOWEL HOLDER COMBO**

SSTDC-17



**FEATURED**  
- 33" 3-DRAWER & ACCESS DOOR COMBO





PROUDLY MADE  
IN THE USA

## STORAGE DRAWERS

Our line of drawers are feature-packed storage options that ensure you get exactly what you need in your backyard set up. Made with #304 stainless steel, these drawers feature heavy-duty flanges and soft closing drawers.



**17" SINGLE DRAWER**

SSDR1-17



**17" DOUBLE DRAWER**

SSDR2-17



**17" TRIPLE DRAWER**

SSDR3-17



**20" VENTED LIQUID PROPANE  
TANK OR TRASH DRAWER**

SSDR1-20LP



**20" TRASH PULLOUT DRAWER**

SSTD1-20



**20" TRASH & RECYCLING  
2-BIN PULLOUT DRAWER**

SSTD2-20



**17" PAPER TOWEL HOLDER**

SSTH-17



**26" UTENSIL DRAWER**

SSDR1-26U



**36" WARMING DRAWER**

SSWD-36



**32" DOUBLE HORIZONTAL  
DRAWER**

SSDR2-32H

### FEATURED

- 20" TRASH PULLOUT DRAWER

## DRY STORAGE

This line of dry storage pantries is a solution that offers heavy-duty weather-resistant seals to give you peace of mind year-round—that means moisture and critters are locked out for good. Made with high quality #304 stainless steel, these pantries feature heavy-duty flanges and magnetic latches.



**36" 2-DRAWER DRY STORAGE PANTRY & ENCLOSED CABINET COMBO**

SSDP-36DC



**36" 2-DRAWER DRY STORAGE PANTRY & ACCESS DOOR COMBO**

SSDP-36AC

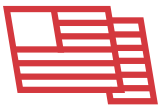

PROUDLY MADE  
IN THE USA





**FEATURED**

- 36" 2-DRAWER DRY STORAGE PANTRY & ENCLOSED CABINET COMBO
- 36" ALTURI GRILL
- 24" 6.6C DELUXE OUTDOOR RATED KEGERATOR



**FEATURED** - 33" MASONRY DOUBLE ACCESS DOOR

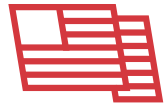

PROUDLY MADE  
IN THE USA

## MASONRY STORAGE

Our line of Masonry Storage is perfect for islands with stone or brick finishes. The increased flange depth makes for a seamless fit and streamlined installation. These #304 stainless steel components can also be used to add an attractive contrast to any island with stucco or Ameristone finishes.



**20" MASONRY VERTICAL  
ACCESS DOOR**

SSDV-20M



**27" MASONRY HORIZONTAL  
ACCESS DOOR**

SSDH-27M



**MASONRY DOUBLE  
ACCESS DOOR (33", 45")**

SSDD-33M / SSDD-45M



**20" MASONRY VENTED  
LIQUID PROPANE TANK OR  
TRASH DRAWER**

SSTD1-20M



**33" MASONRY 2-DRAWER  
& ACCESS DOOR COMBO**

SSDC2-33M



**12" MASONRY ISLAND VENT  
PANEL**

SSIV-12M



**17" MASONRY DOUBLE DRAWER**

SSDR2-17M



**17" MASONRY VERTICAL  
2-DRAWER & PAPER TOWEL  
HOLDER COMBO**

SSTDC-17M

# Grill & Island Accessories

Make your kitchen the way you want it... Summerset offers a variety of miscellaneous conveniences, upgrades, and appliances to customize your outdoor space to your liking. All products feature high-grade #304 stainless steel construction for durability and performance.

## FEATURED

- SIZZLER PRO ROTISSERIE KIT
- 32" SIZZLER PRO GRILL
- 21" 4.5C DELUXE COMPACT REFRIGERATOR
- 30" DOUBLE ACCESS DOOR





## SEAR BURNERS

Become the chef you've dreamed of by using Summerset Sear Burners. Our sear burners can replace nearly any burner position, giving you a customizable cooking experience and allowing you to burn and turn the way you want.

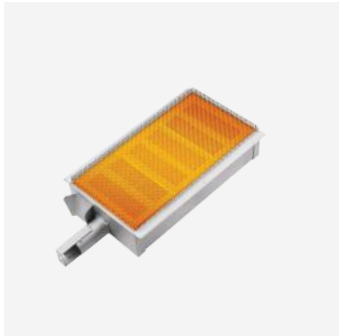

**ALTURI DROP-IN INFRARED SEAR BURNER**

IRB-ALT  
BTU: 26,000



**TRL/TRLD DROP-IN INFRARED SEAR BURNER**

IRB-TRL  
BTU: 18,000



**SIZZLER DROP-IN INFRARED SEAR BURNER**

IRB-SIZ  
BTU: 12,000



**SIZZLER PRO DROP-IN INFRARED SEAR BURNER**

IRB-SIZ  
BTU: 14,000

## GRILL & SIDE BURNER LINERS

Summerset Grill Liners are designed with #304 stainless steel construction to protect any outdoor kitchen made of combustible material. The fitted Grill Liners provide an inch of double-walled insulation that blocks the heat from reaching combustible surfaces or framing such as wood or plastic, giving you the freedom to create your outdoor kitchen in the material of your choice.



**GRILL LINER**

GL-AG30 / GL-AG36 / GL-AG42  
GL-TRL32 / GL-TRL38 / GL-TRLD44 /  
GL-SIZ26 / GL-SIZ32 / GL-SIZ40 /  
GL-GRID30



**SIDE BURNER LINER**

GL-SIZSB2 / GL-TRLSB2 / GL-TRLPB2  
/GL-ASB2 / GL-APB2 / GL-SIZPROPB

## ISLAND ACCESSORIES

For a sleek and well finished outdoor kitchen, count on us to pay attention to even the smallest of details. Trim your refrigerator cutout, seal your umbrella hole and ventilate in style with Summerset's stainless steel accessories. Finishing touches make luxury islands!



**REFRIGERATOR TRIM 15"/21"/24" SERIES**

SSRTK-15 / SSRTK-21 / SSRTK-24 /  
SSRTK-24W



**14" ISLAND VENT PANEL**

SSIV-14



**1.75"/ 2" UMBRELLA COUNTERTOP MOUNTING STANCHION**

SSUS-1 / SSUS-1L



**12"X6" ISLAND VENT PANEL W/ MASONRY FRAME RETURN**

SSIV-12M

## GRIDDLES

Breakfast, burgers, veggies, stir-fry—you name it! Whatever the occasion the Whatever the occasion the griddle is perfect for upgrading your grilling options! Built in the USA with #304 stainless steel, the Summerset griddle plate gives you 212 sq. in. of grilling space!



**18" GRIDDLE PLATE**

SSGP-18

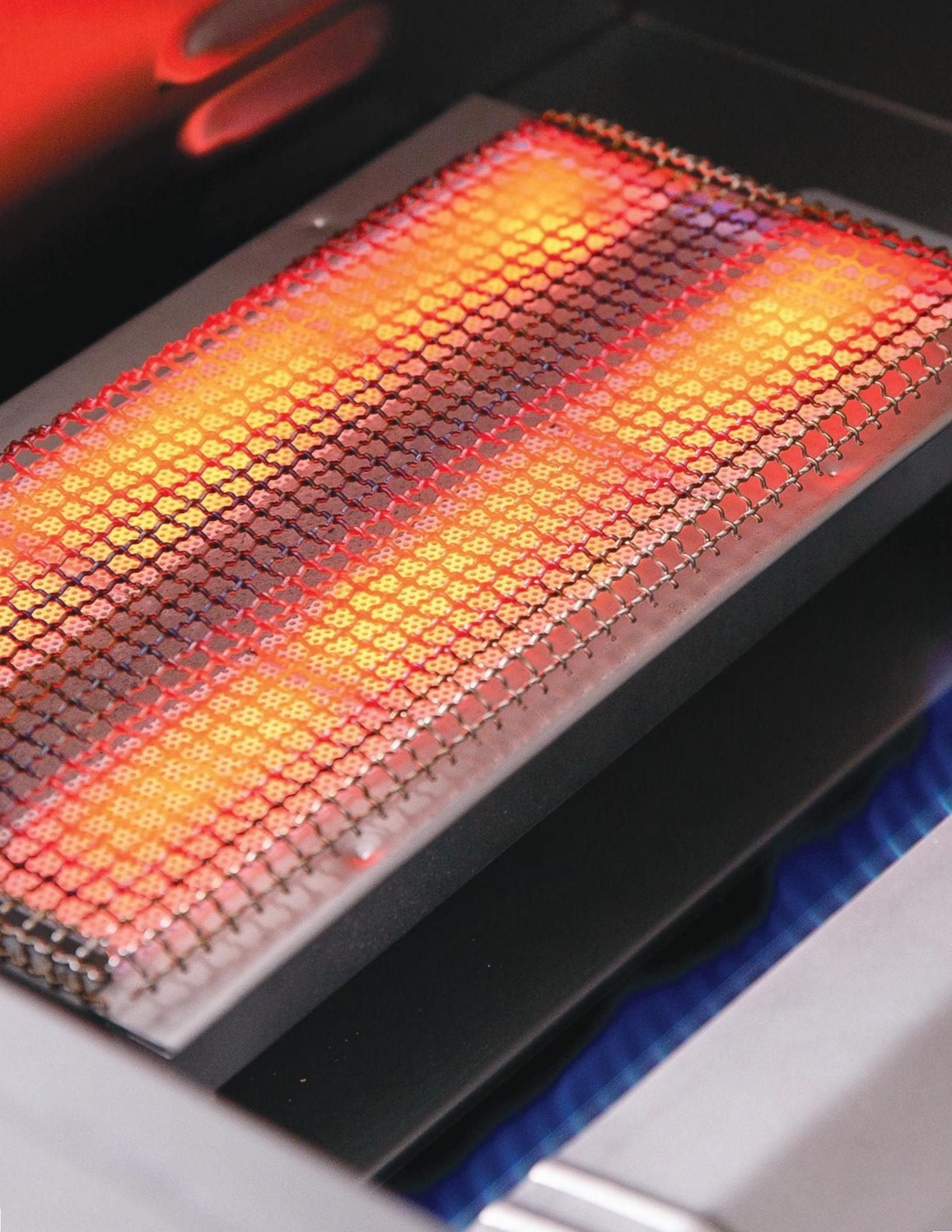





## ROTISSERIE KITS AND BAGS

Complete with weather-protected stainless steel motor, fork set, counterbalance and a spit rod for every grill model, the Summerset Rotisserie Kits have everything you need to start cooking your chicken, turkey, loin or roast like a pro.



**SUMMERSET 40 LB ROTISSERIE**  
 ROTKIT-SIZ26 / ROTKIT-SIZ32 /  
 ROTKIT-SIZ40



**ROTISSERIE KIT STORAGE BAG**  
 GRILLCOV-ROT32 / GRILLCOV-ROT44  
 \*Rotisserie Kit Sold Separately

## APPLIANCE COVERS

Protect your outdoor kitchen appliances with Summerset Grill Covers. Our heavy-duty PVC covers are 100 percent water-resistant, UV-protected to prevent fading, custom fitted, and feature soft flannel backing (to keep your steel scratch-free). Covers available for Grills, Side Burners, & Ovens.



**GRILL COVER**  
 GRILLCOV(-ALT30D, -ALT36D,  
 -ALT42D, -26D, -32D, -38/40D, -44D)  
 SBG30D



**CART COVER**  
 CARTCOV(-ALT30D, -ALT36D,  
 -ALT42D, -26D, -32D, -38/40D, -44D)  
 SBG30D



**SIDE & POWER BURNER COVER**  
 GRILLCOV(-SIZSB2, -SB1, -SB2, -PB,  
 -ALTSB2, -APB2)



**BUILT-IN OVEN COVER**  
 GRILLCOV-OVBI



**FREESTANDING OVEN COVER**  
 CARTCOV-OVFS



**30" GAS GRIDDLE COVER**  
 GRILLCOV-GRID30

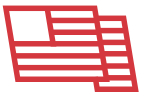

PROUDLY MADE  
IN THE USA

## VENT HOODS



**VENT HOODS (36", 48", 60")**  
SSVH-36 / SSVH-48 / SSVH-60



**12" DUCT COVER (36", 48", 60")**  
SSVH-36-DC / SSVH-48-DC /  
SSVH-60-DC



**SPACER TEMPLATE**  
SSVH-36-SPT / SSVH-48-SPT /  
SSVH-60-SPT



**SPACER BRACKETS (4", 8")**  
SSVH-36-SP4 / SSVH-48-SP4 /  
SSVH-60-SP4 / SSVH-36-SP8 /  
SSVH-48-SP8 / SSVH-60-SP8

## SIZZLER/ SIZZLER PRO SIDE BURNER BRACKET

Exclusively, the Sizzler models now have even more surface for grilling with the Side Burner Bracket. This unique design allows you to replace the right- or left-hand side shelf with a housing bracket to simply mount a double side burner right next to your grill.



### SIDE BURNER BRACKET

CART-SIZ-SB2BK / CART-SIZ-SB2BK-L

## GAS TIMER / MOUNTING PLATE

Bring utility and safety to your gas grill with the Summerset Gas Timer. Built with matching durable #304 stainless steel to weather the elements, this 1 hour timer features a simple and sleek design.

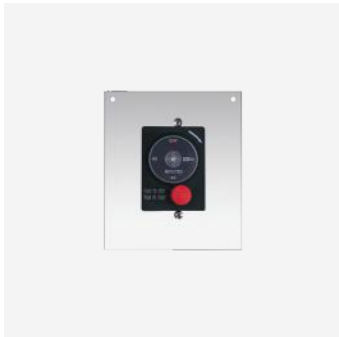

### GAS TIMER WITH EMERGENCY SHUTOFF / MOUNTING PLATE

ESTOP1-0H

\*Mounting Plate Sold Separately



### GAS TIMER LOCKING CABINET

ESTOP-LC-KIT / ESTOP-RM-KIT

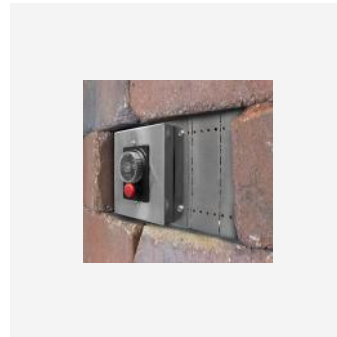

### EXPANDABLE MASONRY GAS TIMER KIT

ESTOP-CP-KIT

## WIND GUARDS



### 36" STAINLESS STEEL WIND GUARD (FITS 30"-32" GRILLS)

SSWG-36



### 48" STAINLESS STEEL WIND GUARD (FITS 36"-44" GRILLS)

SSWG-48

## CUTTING BOARD & TRASH CHUTE

Add convenience to your outdoor kitchen with the Summerset Grills Cutting Board & Trash Chute. Add the Trash Chute above Summerset's Trash Drawer for easy cleanup. Made from #304 Stainless Steel, Summerset's Trash Chute is durable even in the harshest weather.



**14" TRASH CHUTE & CUTTING BOARD WITH LID**

SSTC-14

## SMOKER TRAYS

Add some pizzazz to an otherwise ordinary meal with the Summerset Smoker Tray. Whether it's mesquite chicken or applewood smoked salmon, the smoker tray is the ultimate meal enhancer that allows for endless flavor options.



**SMOKER TRAYS**

SSMK-SIZ / SSMK-TRL



**ALTURI SMOKER TRAY**

SSMK-ALT

## OVEN ACCESSORIES

Here are all the included tools that you will need for a successful night of pizza making. Be sure you use that glove, because this pizza will be coming out of the oven hot!



**PIZZA STONE KIT**

SSTOAK-1



**FLANGE KIT**

OV-FLANG KIT



## Cutouts

For cutouts, dimensions or more information on your Summerset product, visit [Summersetgrills.com/cutouts](https://Summersetgrills.com/cutouts) or scan this QR Code with your smartphone's camera app.

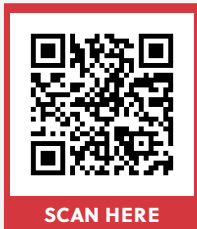

SCAN HERE

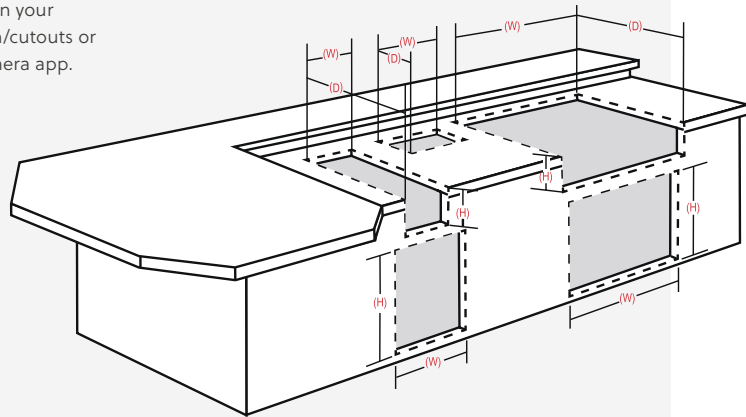





\*SHOWN WITH HIDDEN UTENSIL DRAWER

# Indoor / Outdoor Electric & Gas Heaters

Our Indoor / Outdoor Gas & Electric Heating products are the gathering place and focal point that spaces are built around. So, whether it's a backyard patio, outdoor bar, living room or hotel lobby, this line of heaters is the perfect solution to make spaces more efficient and comfortable no matter what the need.









## DGR SERIES

OUTDOOR INFRARED PROPANE & NATURAL GAS HEATERS

- High-performance ceramic burner - 31,500 BTU.
- Suitable for residential and commercial application.
- World-class wind protection up to 9.9 mph (16 km/hr).
- Provides an easy setup with some assembly required.
- 4 tile ceramic burner.
- Electronic finger pull for easy ignition and turn-off.
- Protective grille and reflector included.
- Safety tilt switch ensures safe operation.



**DGR OUTDOOR WALL MOUNTED  
NG INFRARED HEATER**  
X-DGR32WNG



**OUTDOOR INFRARED PORTABLE  
PROPANE HEATER**  
X-DGR32PLP-HEAD &  
X-DGR32PLP-STAND



## DIR SERIES

OUTDOOR/INDOOR INFRARED HEATERS

- Schott Nextrema® glass combines high-temperature, thermal shock and chemical resistance, excellent infrared transmission, non-porous surface and attractive design.
- Ruby halogen bulb provides full power in under 6 seconds.
- IP65 rated for outdoor or indoor use.
- Anodized aluminum casing provides long life.
- Up to 5,000 hours of running life.
- Includes pivoting mounting bracket.
- Designed for permanent installations on a dedicated circuit.



### DIR SERIES (1500W, 1800W, 2200W, 3000W)

X-DIR15A10GR / X-DIR18A10GR /  
X-DIR22A10GR / X-DIR30A10GR

## X-DIRP PLUG IN UNIT

OUTDOOR/INDOOR INFRARED HEATERS

- Schott Nextrema glass combines high-temperature, thermal shock and chemical resistance, excellent infrared transmission, non-porous surface and attractive design.
- Ruby halogen bulb provides full power in under 6 seconds.
- Ensures a safe, easy and space-saving installation. Includes pivoting mounting bracket.
- 3 power settings: low (600W), medium (1050W), high (1500W).
- Set timer to automatically shut off the heater after a preset time, up to 13 hrs.
- Shows power setting and timer function at a glance.
- 7.7 ft cord with ground plug, standard 120V outlet.



### DIR PLUG IN HEATER

X-DIRP15A10GR



## DLW SERIES

OUTDOOR/INDOOR RADIANT SERIES

- Slim profile is perfect for ceiling and wall-mount applications.
- Warms like the sun, heating people and objects with zero visible light or glare.
- Safe, reliable design with an IP55 rating that provides protection against dust and water.
- Fully assembled, simply mount, and hardwire using the easy to access top-mounted junction box.
- Offers flexibility in design with color options - choose either white or black to suit your style needs.
- Designed for permanent installations on a dedicated circuit.
- Designed for hard-wired controls – switch or timer (not included).

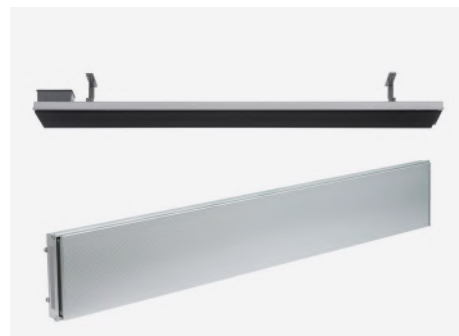

### DLW SERIES (1500W, 2400W, 3200W)

X-DLW1500B12 / X-DLW1500W12 / X-DLW2400B24 /  
X-DLW2400W24 / X-DLW3200B24 / X-DLW3200W24



## DSH SERIES

### OUTDOOR/INDOOR INFRARED HEATERS

- Get heat on demand with a gold-tube quartz element that provides full power in under 6 seconds.
- Suitable for all climates, with an IP65 rating for outdoor or indoor use.
- Each heater comes with the element pre-installed, which eases the installation and reduces the risk of damaged, broken or misplaced elements upon delivery.
- For optimum heat, direct the unit toward the area you want to warm up.
- Stay in control, multiple heaters can be operated with a single remote.
- Unit has safety mechanism that automatically places the heater in Standby mode after 8 hours of continuous operation.



**DSH SERIESV**  
X-DSH20W

## GOLD STANDARD WARRANTY

---

Your investment in AMD Direct products is backed by the strongest warranty in the industry. In addition to precision engineering and outstanding performance, AMD Direct products include our GOLD STANDARD LIFETIME WARRANTY with all replacement parts 100% non-prorated. Effective with purchases as of 8/1/21.

AMD Direct Warranty is valid for original purchaser at original site of delivery with proof of purchase and photo documentation only. Registration form must be submitted online within 30 days of the purchase date to validate the warranty. Warranty is void upon transfer of ownership. Warranty does not apply to products installed in any commercial, rental, or nonresidential application (exception of the Resort Grill, Alturi, & TRL). Warranty covers replacement parts only. Manufacturer is not responsible for labor or labor-related costs. Warranty does not cover discoloration, surface rust, corrosion, or oxidation, which may occur due to harsh environments, chemicals, or overheating. Warranty will not apply for damage resulting from improper installations, abuse, extreme environments, grease fires, or misuse. Proof of regular and proper maintenance is required. Coastal, humid, and/or salt environments are subject to manufacturer review. All out-of-box claims must be made within 30 days of purchase and must be made prior to installation. Any product installed damaged will be considered damaged during installation and not covered under warranty. Warranty and registration forms are available at [www.amddirect.com/register](http://www.amddirect.com/register). Please be advised - all display models are sold "as is" and the warranty covers the following items only: main burners (Gold Standard Lifetime Warranty), grates (Gold Standard Lifetime Warranty), burner covers (Gold Standard Lifetime Warranty). All warranties are subject to the review and approval of the manufacturer.

---

14520 DELTA LANE SUITE 105,  
HUNTINGTON BEACH, CA 92647

800.966.8126

AMDDIRECT.COM



## **AMD DIRECT GAS APPLIANCES (GRILLS, SIDE/POWER BURNERS, GAS GRIDDLE & OVEN)**

- Gold Standard Lifetime Warranty on construction and manufacturer defects
- Gold Standard Lifetime Warranty on Stainless Steel Construction
- Gold Standard Lifetime Warranty on Cooking Grates, Burners, Burner Covers, Valves, Flame Tamers, and Heatzone Separators, Temperature Gauges, & Hood Springs
- Gold Standard Lifetime Warranty on Briquette Systems
- 3 YEAR Warranty on all other Parts, Components, & Electrical, including: LED Bulbs, Wire Harness, & Switches; Power Source Wire; Transformer; Interior Halogen Light Wire & Bulb

## **VENT HOODS, REFRIGERATION, COLD STORAGE & SINKS**

### **VENT HOODS**

- 5 Year Warranty on all Stainless Steel Construction
- 3 Year Warranty on Blowers, LED Lighting, Wiring Harness and Switches

### **15" & 24" REFRIGERATION MODELS**

- 3 Year Warranty on all construction including Compressors
- 1 Year Warranty on Transformer, LED Bulbs, LED Harness, Power Source Wire, LED Switches, Interior Halogen Light Wire/Bulbs

### **21" REFRIGERATION MODELS**

- 1 Year Warranty on all Construction & Electrical components including Compressor, Transformer, LED Bulbs, LED Harness, Power Source Wire, LED Switches, Interior Halogen Light Wire/Bulbs

### **COLD STORAGE & SINKS**

- Gold Standard Lifetime Warranty on Ice Chest
- Gold Standard Lifetime Warranty on Drains & Faucets

## **DRAWERS, DOORS, GRILL LINERS, & CARTS**

- Gold Standard Lifetime Warranty on Construction, Workmanship and Materials for all Stainless Steel parts, Including Doors, Drawers, Grill Liners, & Carts
- 3 Year Warranty on Electrical (Warming Drawers)

## **COVERS**

- Gold Standard Lifetime Warranty on Covers, including Grills, Carts, Side/Power Burners, Gas Griddle & Oven

## **COMMERCIAL APPLICATIONS**

### **GAS GRILLS**

- Gold Standard Lifetime Warranty on Workmanship, Construction, & manufacturer defects for all commercial and/or hospitality applications
- Warranty is void upon misuse, including lack of regular cleaning, vandalism, or theft
- Warranty is valid only if regular maintenance is exercised. Due to the nature of commercial applications (multiple users, lack of control of use, etc.) regular maintenance is mandatory







**FEATURED**

- 42" ALTURI GRILL
- TWO 24" 5.3C DELUXE OUTDOOR RATED REFRIGERATORS
- ALTURI LIGHTED SEAR SIDE BURNER



# SUMMERSET

14520 Delta Ln  
Suite 105  
Huntington Beach,  
CA 92647

(800) 966-8126

[SUMMERSETGRILLS.COM](http://SUMMERSETGRILLS.COM)