

Wood-Burning Fireplaces  
BEAUTY BY DESIGN





# WarmMajic II

## EPA Wood-Burning Fireplace

Enhance your home's heating profile with a clean-burning, efficient wood fireplace you can depend on. This eco-friendly wood fireplace exceeds the strictest environmental standards. Come home to the comfort of the WarmMajic II wood fireplace and enjoy big heat and bold flames.



Cover and Above: WarmMajic II shown with standard cast iron doors and firebrick interior

### WarmMajic II Quick Look

- Eco-friendly EPA certified
- High performance dual fans with adjustable speed controls distribute a constant flow of heat
- Heat management solutions to heat your whole home
- 68,200 BTUs—heats 1,000 to 2,600 sq. ft. depending on climate and home efficiency
- 22" recommended log length and 2.7 cu. ft. interior capacity
- Modern technology makes starting your fire easier and enables up to 10 hours of burn time



# Ashland

## Wood-Burning Fireplace

The Ashland delivers on every level; customize the design with three available sizes and stylish finishing options. The large firebox gives you a front row seat for unforgettable fires, while the proven history of performance provides peace of mind for many years to come.\*



Above: Ashland 36 shown with standard mesh screen and herringbone interior panels

### Ashland Quick Look

- Three sizes available: 36", 42" or 50"
- Flush-hearth design for seamless finishing
- Two standard outside air kits for enhanced venting
- Traditional or herringbone interior panels
- Optional bi-fold glass doors in two finishes
- Variety of gas logs available

\*Not for use in Canada



Ashland 50 shown with standard mesh screen and herringbone interior panels



# Biltmore

## Wood-Burning Fireplace

The Biltmore is the largest wood burning fireplace in the industry. The expansive viewing area, classic masonry style and clean face design becomes the natural focal point of any room, and the perfect place to relax.\*

### Biltmore Quick Look

- Three sizes available: 36", 42" or 50"
- Clean face design enables finishing materials to be applied up to firebox opening
- Can be installed flush with floor or on a raised hearth
- Traditional or herringbone interior panels
- Three door style options in one finish
- Variety of gas logs available

\*Biltmore 50" not for use in Canada

Above: Biltmore 80 shown with traditional brick interior panels and standard mesh screen

# Sovereign

## Wood-Burning Fireplace

Some things never go out of style, like the beauty and craftsmanship of a Sovereign wood-burning fireplace. Authentic masonry design and attractive finishing options allow you to create a masterpiece with long-lasting value.

### Sovereign Quick Look

- Two sizes available: 36" or 42"
- Radiant or heat-circulating options
- Traditional brick interior panels
- Three door style options in two finishes
- Variety of gas logs available

Sovereign 42 shown with traditional brick interior panels and standard mesh screen



# Royalton

## Wood-Burning Fireplace

The Royalton has earned a strong reputation for classical style, superior performance and outstanding features. The detailed brick interior with classic masonry look, up to 42" viewing area and available glass doors make this fireplace a stunning addition to your home's décor.



### Royalton Quick Look

- Two sizes available: 36" or 42"
- Convenient ash lip
- Front damper handle locks in open/closed positions
- Traditional brick interior panels
- Optional bi-fold glass doors in two finishes
- Variety of gas logs available

Royalton BE42 shown with traditional brick interior panels and standard mesh screen

# Designer See-Through

## Wood-Burning Fireplace

Now you can enjoy the incomparable warmth and beauty of your wood-burning fireplace from two rooms at once. Get twice the ambiance with a Designer see-through fireplace.



### Designer See-Through Quick Look

- Two sizes available: 36" or 42"
- Authentic masonry appearance
- Clean face design
- Outside air kit for enhanced venting
- Optional bifold glass doors in two finishes
- Variety of gas logs available

Above and below: Designer See-Through 42" shown with standard interior and mesh screen

# ACCESSORIES FOR YOUR WOOD FIREPLACE

## DOOR STYLES



Grand Vista Mesh Doors



Gasketed Glass Doors



Bi-fold Glass Doors



Contour Screen Doors

## DOOR FINISHES



Black



Bronze



Stainless Steel

## INTERIOR PANELS

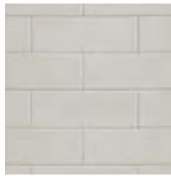

Traditional Brick



Herringbone Brick

## TERMINATION CAPS



Decorative faux-copper finish

OPTIONS AND ACCESSORIES		WARMMAJIC II	ASHLAND	BILTMORE	SOVEREIGN	ROYALTON	DESIGNER SEE-THROUGH
DOORS	Bifold Glass Doors		Black, Bronze	Black	Black, Stainless Steel	Black, Stainless Steel	Black, Stainless Steel*
	Grand Vista Mesh Doors			Black	Black, Stainless Steel		
	Contour Screen Doors			Black			
	Gasketed Glass Doors	●			Black		
INTERIORS	Traditional	Firebrick	●	●	●	●	
	Herringbone		●	●			
LOGS	Various Gas Logs		●	●	●	●	●

For gas log options, visit [majesticproducts.com](http://majesticproducts.com) or [majesticfireplaces.ca](http://majesticfireplaces.ca).

\* Stainless steel finish available for 36" only

## TECHNICAL SPECIFICATIONS

### WarmMajic II

MODEL	FRONT WIDTH (A)		HEIGHT (B)		DEPTH (C)		REAR WIDTH (D)		FIREPLACE OPENING (E X F)
	ACTUAL	FRAMING	ACTUAL	FRAMING	ACTUAL	FRAMING	ACTUAL	FRAMING	
WARMMAJIC II	40" (1016mm)	42-1/2" (1067mm)	40-1/2" (1029mm)	56-3/4" (1441mm)	23-1/2" (597mm)	24** (610mm)	40" (1016mm)	42-1/2" (1067mm)	37" x 31-1/8" (940mm x 791mm)

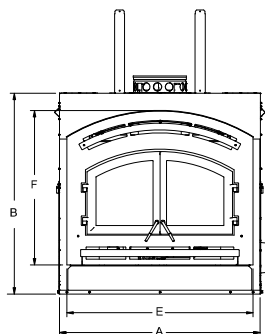

Front View

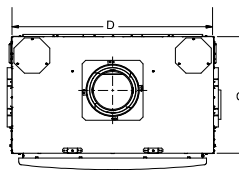

Top View

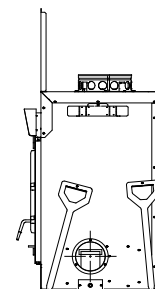

Side View

\*\*If interior of chase will be drywalled, add the thickness to this measurement.

# TECHNICAL SPECIFICATIONS

## Ashland

MODEL	FRONT WIDTH (A)		HEIGHT (B)		DEPTH (C)		REAR WIDTH (D)		FIREPLACE OPENING (E X F)
	ACTUAL	FRAMING	ACTUAL	FRAMING	ACTUAL	FRAMING	ACTUAL	FRAMING	
ASH36	46-7/8" (1191mm)	47-7/8" (1194mm)	74-1/8" (1883mm)	74-1/2" (1892mm)	27-1/2" (699mm)	28-1/2" (724mm)	31-1/8" (787mm)	47-7/8" (1194mm)	36" x 38" (914mm x 965mm)
ASH42	52-7/8" (1343mm)	53-7/8" (1368mm)	74-1/8" (1883mm)	74-1/2" (1892mm)	27-1/2" (699mm)	28-1/2" (724mm)	37-1/8" (943mm)	53-7/8" (1368mm)	42" x 38" (1067mm x 965mm)
ASH50	60-7/8" (1524mm)	61-7/8" (1549mm)	74-1/8" (1883mm)	74-1/2" (1892mm)	27-1/2" (699mm)	28-1/2" (724mm)	45-1/8" (1147mm)	61-7/8" (1549mm)	50" x 38" (1270mm x 965mm)

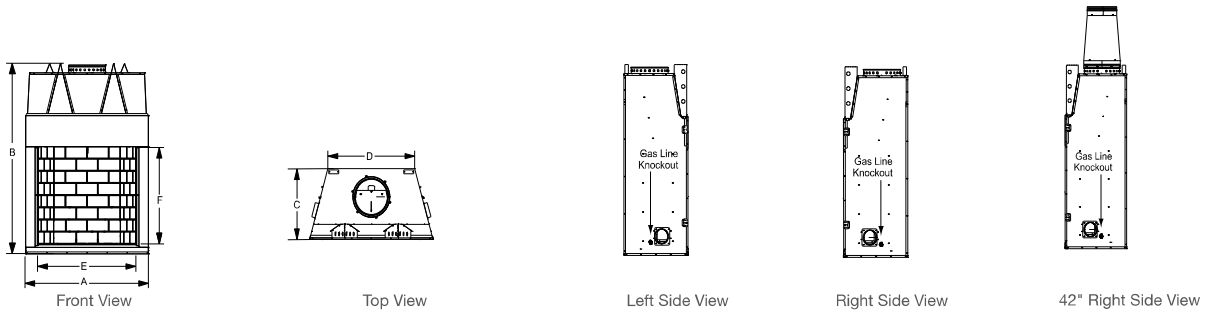

## Biltmore

MODEL	FRONT WIDTH (A)		HEIGHT (B)		DEPTH (C)		REAR WIDTH (D)		FIREPLACE OPENING (E X F)
	ACTUAL	FRAMING	ACTUAL	FRAMING	ACTUAL	FRAMING	ACTUAL	FRAMING	
SB60	44-1/2" (1130mm)	45-1/2" (1158mm)	59-1/4" (1505mm)	59-3/4" (1518mm)	27-1/2" (699mm)	28" (711mm)	28-5/8" (727mm)	45-1/2"	36" x 28-1/2" (914mm x 724mm)
SB80	50-1/2" (1283mm)	51-1/2" (1301mm)	59-1/4" (1505mm)	59-3/4" (1518mm)	27-1/2" (699mm)	28-1/2" (724mm)	34-1/2" (876mm)	51-1/2" (1308mm)	42 x 28-1/2" (1067mm x 724mm)
SB100	60-5/8" (1540mm)	61-5/8" (1565mm)	70-1/2" (1791)	71" (1803mm)	29-1/2" (749mm)	30-1/2" (775mm)	41-5/8" (1057mm)	61-5/8" (1565mm)	50" x 33" (1270mm x 838mm)

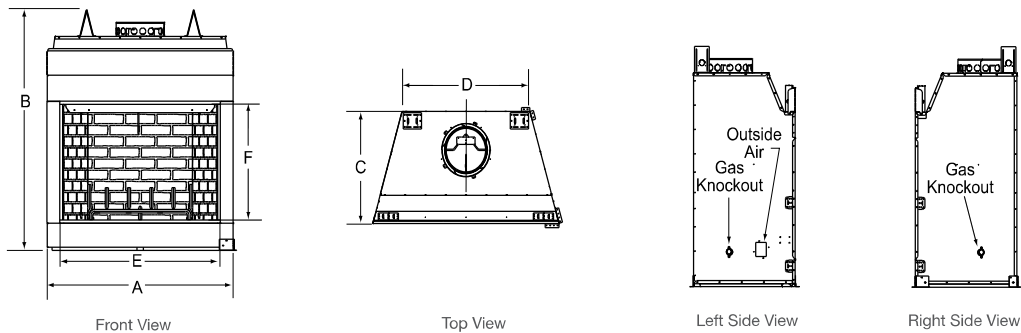

## Sovereign

MODEL	FRONT WIDTH (A)		HEIGHT (B)		DEPTH (C)		REAR WIDTH (D)		FIREPLACE OPENING (E X F)
	ACTUAL	FRAMING	ACTUAL	FRAMING	ACTUAL	FRAMING	ACTUAL	FRAMING	
SA36	42" (1067mm)	43" (1092mm)	41-1/4" (1048mm)	41-1/2" (1054mm)	22-3/4" (578mm)	23" (584mm)	28-1/4" (718mm)	43" (1092mm)	36" x 23-3/8" (914mm x 594mm)
SA42	48" (1219mm)	49" (1245mm)	41-1/4" (1048mm)	41-1/2" (1054mm)	22-3/4" (578mm)	23" (584mm)	30-7/8" (784mm)	49" (1245mm)	42" x 23-3/8" (1067mm x 594mm)

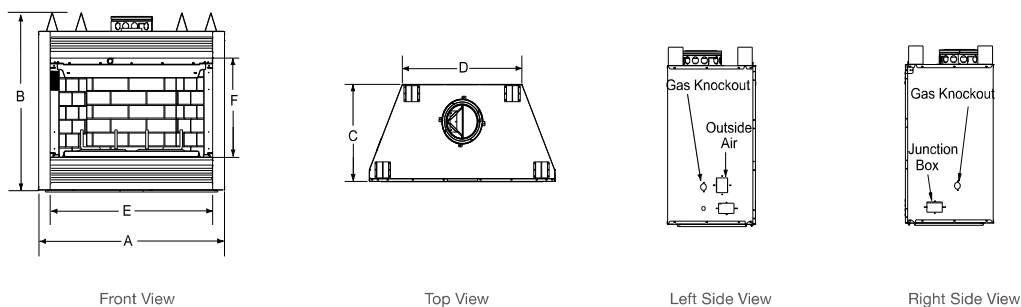

## Royalton

MODEL	FRONT WIDTH (A)		HEIGHT (B)		DEPTH (C)		REAR WIDTH (D)		FIREPLACE OPENING (E X F)
	ACTUAL	FRAMING	ACTUAL	FRAMING	ACTUAL	FRAMING	ACTUAL	FRAMING	
BE36	41" (1041mm)	42" (1067mm)	39-1/2" (1003mm)	39-3/4" (1010mm)	21-3/8" (543mm)	21-1/2" (546mm)	23-3/4" (603mm)	42" (1067mm)	36" x 21" (914mm x 533mm)
BE42	47" (1194mm)	48" (1219mm)	39-1/2" (1003mm)	39-3/4" (1010mm)	21-3/8" (543mm)	21-1/2" (546mm)	29-3/4" (756mm)	48" (1219mm)	42" x 21" (1067mm x 533mm)

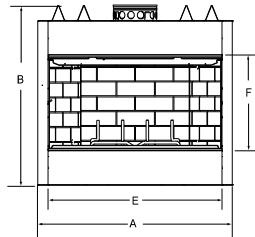

Front View

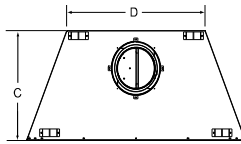

Top View

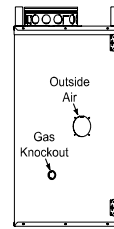

Left Side View

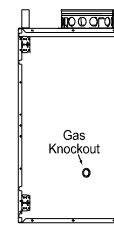

Right Side View

## Designer See-Through

MODEL	FRONT WIDTH (A)		HEIGHT (B)		DEPTH (C)		REAR WIDTH (D)		FIREPLACE OPENING (E X F)
	ACTUAL	FRAMING	ACTUAL	FRAMING	ACTUAL	FRAMING	ACTUAL	FRAMING	
DSR36	40" (1016mm)	41" (1041mm)	47-1/4" (1200mm)	41-1/2" <sup>2</sup> (1054mm)	24" (610mm)	23" (585mm)	40" (1016mm)	41" (1041mm)	36" x 20-7/8" (914mm x 530mm)
DSR42	47" (1194mm)	48" (1219mm)	58-7/8" (1496mm)	39-1/8" <sup>2</sup> (994mm)	28" (711)	27" (686mm)	47" (1194mm)	48" (1219mm)	42" x 23" (1067mm x 585mm)

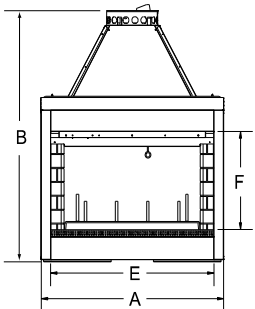

Front View

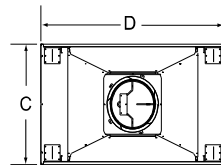

Top View

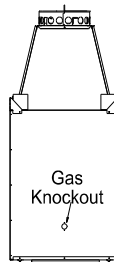

Left Side View

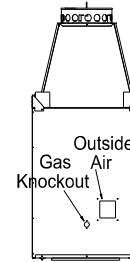

Right Side View

2 Framing must be filled in to top of front standoff after unit is installed.

**Your Majestic Dealer:**

To avoid personal injury or property damage, the product described by this brochure must be installed, operated and maintained in strict compliance with the instructions packaged with the product and all applicable building or fire codes. Contact local building or fire officials about restrictions and installation inspection requirements. All photographs and drawings on this brochure are for illustrative purposes only and are not intended for, nor should they be used as a substitute for the instructions packaged with the unit. Appearance and specifications of the product are subject to change without notice. ©2018 Hearth & Home Technologies

majesticproducts.com  
majesticfireplaces.ca

