



Service Manual



Model

RBF24DLX
RBF30
RBF36
RBF36P
RBF42

Part Number

6909990100
6909780100
6909790100
6909790200
6909800100

IMPORTANT SAFETY INFORMATION: Always read this manual first before attempting to service this firebox. For your safety, always comply with all warnings and safety instructions contained in this manual to prevent personal injury or property damage.

TABLE OF CONTENTS

Operation - RBF30, RBF36, RBF36P, RBF42	3
Operation - RBF24DLX	5
Maintenance	7
Exploded Parts Diagram - RBF30, RBF36, RBF36P, RBF42	8
Replacement Parts List	8
Exploded Parts Diagram - RBF24DLX	9
Replacement Parts List	9
Wiring Diagram - RBF30, RBF36, RBF36P, RBF42	10
Wiring Diagram - RBF24DLX	10
Preparing for Service	11
Ember LED Light Replacement	12
Flame Base LED Replacement	12
Flame LED Replacement	12
Flicker Motor Replacement (<i>RBF30, RBF36, RBF36P, RBF42</i>)	12
Flicker Motor Replacement (<i>RBF24DLX</i>)	12
Main Control Board Replacement	13
Power Supply Replacement	13
Blower Assembly Replacement (<i>RBF30, RBF36, RBF36P, RBF42</i>)	14
Element Replacement (<i>RBF30, RBF36, RBF36P, RBF42</i>)	14
Cutout Replacement (<i>RBF30, RBF36, RBF36P, RBF42</i>)	15
Heater Assembly Replacement (<i>RBF24DLX</i>)	15
Touch Pad Replacement	16
Thermistor Replacement (<i>RBF24DLX</i>)	16
Thermistor Replacement (<i>RBF30, RBF36, RBF36P, RBF42</i>)	17
Top Front Lights Replacement	17
Rear Top Lights Replacement	17
Troubleshooting Guide	18

Always use a qualified technician or service agency to repair this firebox.

! NOTE: Procedures and techniques that are considered important enough to emphasize.

⚠ CAUTION: Procedures and techniques which, if not carefully followed, will result in damage to the equipment.

⚠ WARNING: Procedures and techniques which, if not carefully followed, will expose the user to the risk of fire, serious injury, or death.

Operation - RBF30, RBF36, RBF36P, RBF42

Figure 1

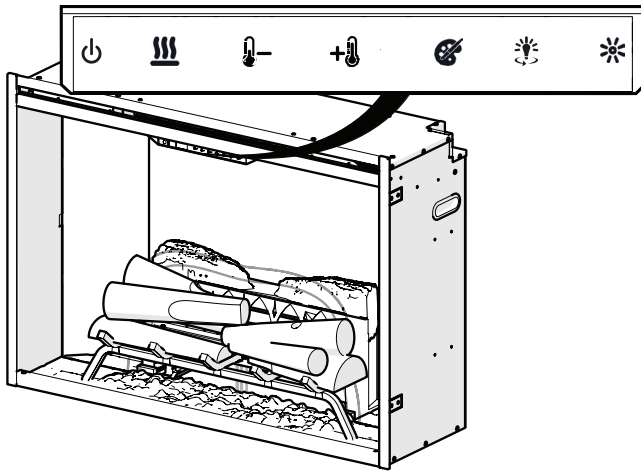
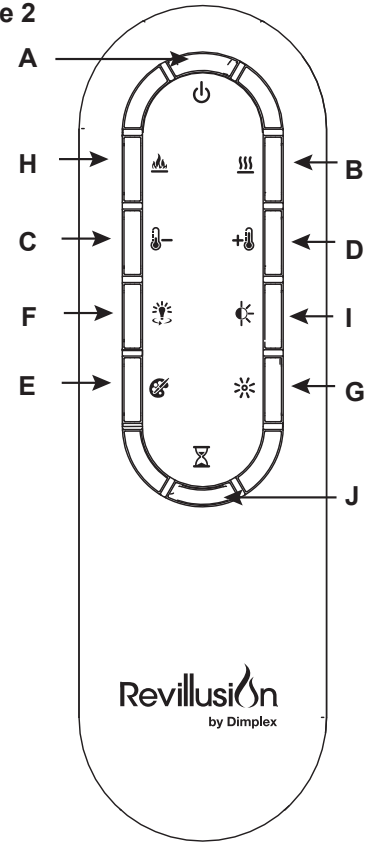

Figure 2



Touch Panel and Remote Controls



















⚠ WARNING: The Revillusion™ Built-in Electric Firebox must be installed properly before it is used.

⚠ CAUTION: Except for installation and cleaning described in this manual, an authorized service representative should perform any other servicing.

The manual controls for the Revillusion™ Built-in Electric Firebox are located on the front panel. Touch an icon to activate. The selected setting displays on the left side of the panel.

A multi-function remote control also is provided. The remote control has a range of approximately 30' (9 m). To operate correctly, the remote control must be pointed toward the front of the built-in electric firebox.

	Icon	Function	Description
A		Power/ Standby	<p>Press to activate the current standby state (On/Off).</p> <ul style="list-style-type: none"> • Standby State On Press to turn everything Off. Press again to activate the previous state. • Standby State Off Press to activate the previous state. <ul style="list-style-type: none"> - If the flame effect was On, the previous heat setting will be activated (On or Off). - If the flame effect was Off, the previous heat setting will be activated (High or Low). <p>Press again to turn everything Off.</p>
B		Heat	<ul style="list-style-type: none"> • Heat On Press to turn heat On (indicated by 1 short beep and the icon appearing on the display). Displays current heater temperature setting. Use the Temp Up/Down icon to change the heater temperature setting. • Heat Off Press to turn heat Off (indicated by 1 short beep). <p>! NOTE: After the heater is switched off, the fan will continue on for 60 seconds before turning off.</p>

	Icon	Function	Description
C		Temp Down	Press multiple times to lower the heater temperature in 1° F (1° C) increments. Displays current temperature; lowest temperature is 41° F (5° C). This feature is active whenever the heat is enabled.
D		Temp Up	Press multiple time to raise the heater temperature in 1° F (1° C) increments. Displays current temperature; highest temperature is 99° F (37° C). This feature is active whenever the heat is enabled.
Change Fahrenheit (° F) to Celsius (° C)			Press both Temp+ (+ ) and Temp- () on the unit.
Heat Enable			Hold both Heat () and Temp- () , on the unit, for 2 seconds. Temperature displays on the screen.
Heat Disable			Hold both Heat () and Temp- () , on the unit, for 2 seconds, when temperature is adjusted "---" displays on the screen.
E		Color Themes	Press multiple times to change the flame base colors from Red to Blue to Off. (The first segment on the display will change from "r" to "b" to blank) This feature is active only when the flame effect is On.
F		360° Light	Press multiple times to change the LEDs on the sides and back of the unit from Midnight mode to white to yellow to red. (The middle segment on the display will change through 0 - 3 respectively. This feature is active only when the Flame is ON.)
G		Brightness	Press to change the LED lights from High to Low. (The last segment on the display will change from "H" to "L") The Realog™ LEDs remain On when the heater is ON and the flame effect is Off. ! NOTE: When the Light Sensor is activated, High and Low flickering brightness settings are also available (Flashing "H" and "L").
H		Flame	Press to light the log set and start the flame effect. Press again to turn feature Off.
I		Light Sensor	Press to activate the ambient light sensor (ALS ON). Press again to turn the sensor off (ALS OFF). ! NOTE: The light sensor will adjust the brightness of the fireplace based on the ambient light in the room.
J		Timer	Press multiple times to change the sleeper timer in 0.5 hr increments from 0.5 hr to 8.0 hr before turning off. The remaining time on the sleep timer displays.
Control Lock			Hold both Temp- () and Brightness () , on the unit, for 2 seconds to disable the manual controls.
Control Unlock			Hold both Temp- () and Brightness () , on the unit, for 2 seconds to enable the manual controls.





Resetting the Temperature Cutoff Switch



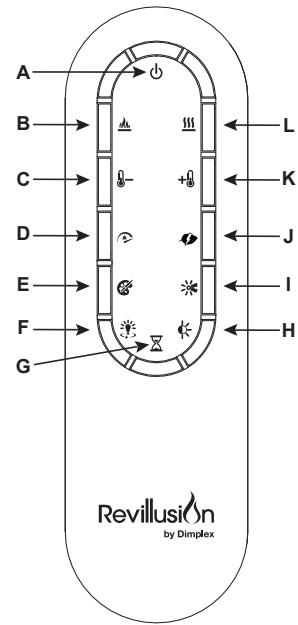
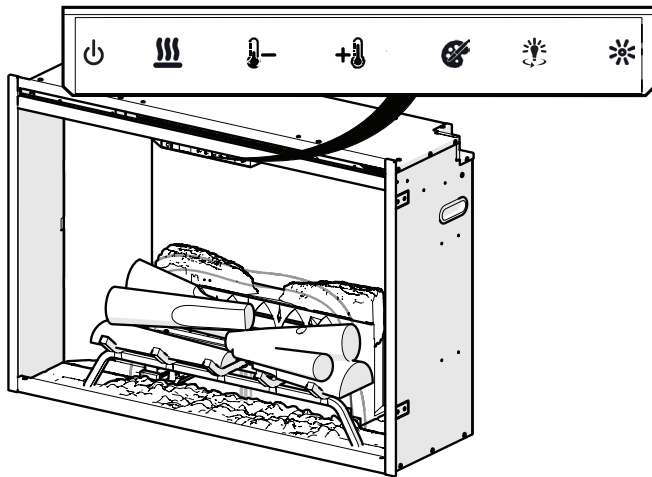













Should the heater overheat, an automatic cut out will turn the heater off and it will not come back on without being reset. It can be reset by disconnecting power at the main electrical panel and waiting 5 minutes before plugging the unit back in.

⚠ CAUTION: If you need to continuously reset the heater, unplug the unit and call technical support at 1-888-346-7539.

Operation - RBF24DLX



	Icon	Function	Description
A		Power/Standby	<p>Press to activate the current standby state (On/Off).</p> <ul style="list-style-type: none"> • Standby State On Press to turn everything Off. Press again to activate the previous state. • Standby State Off Press to activate the previous state. <ul style="list-style-type: none"> - If the flame effect was On, the previous heat setting will be activated (On or Off). - If the flame effect was Off, the previous heat setting will be activated (High or Low). <p>Press again to turn everything Off.</p>
B		Flame	Press to light the log set and start the flame effect. Press again to turn feature Off.
C		Temp Down	Press multiple times to lower the heater temperature in 1 °F (1 °C) increments. Displays current temperature; lowest temperature is 41 °F (5 °C). This feature is active whenever the heat is enabled.
	Icon	Function	Description
D		Flame Speed	Press multiple times to toggle through the flame speeds (minimum, medium, maximum). The display will show the current speed number, F1, F2 or F3.
E		Color Themes	Press multiple times to change the flame base colors from Red to Blue to Off. (The first segment on the display will change from "r" to "b" to blank) This feature is active only when the flame effect is On.

	Icon	Function	Description
F		360° Light	Press multiple times to change the LEDs on the sides and back of the unit from Midnight mode to white to yellow to red. (The middle segment on the display will change through 0 - 3 respectively. This feature is active only when the Flame is ON.)
G		Timer	Press multiple times to change the sleeper timer in 0.5 hr increments from 0.5 hr to 8.0 hr before turning off. The remaining time on the sleep timer displays.
H		Light Sensor	Press to activate the ambient light sensor (ALS ON). Press again to turn the sensor off (ALS OFF). ! NOTE: The light sensor will adjust the brightness of the fireplace based on the ambient light in the room.
I		Brightness	Press to change the LED lights from High to Low. (The last segment on the display will change from "H" to "L") The Realog™ LEDs remain On when the heater is ON and the flame effect is Off. ! NOTE: When the Light Sensor is activated, High and Low flickering brightness settings are also available (Flashing "H" and "L").
J		Heat Mode	Press the multiple time to toggle through the heat modes (Normal, Eco and Boost). Normal is indicated with a Nor on the display, ECO is indicate by an Eco on the display and Boost is indicate by a b20 on the display. In boost mode, a time is set initial for 20 minutes and the display will indicate b19, b18, etc., as the time counts down. This is shown by pressing the heat mode button.
K		Temp Up	Press multiple time to raise the heater temperature in 1 °F (1 °C) increments. Displays current temperature; highest temperature is 99 °F (37 °C). This feature is active whenever the heat is enabled.
Change Fahrenheit (°F) to Celsius (°C)			Press both Temp+ () and Temp- () on the unit.
Heat Enable			Hold both Heat () and Temp- (), on the unit, for 2 seconds. Temperature displays on the screen.
Heat Disable			Hold both Heat () and Temp- (), on the unit, for 2 seconds, when temperature is adjusted "---" displays on the screen.
L		Heat	<ul style="list-style-type: none"> • Heat On Press to turn heat On (indicated by 1 short beep and the icon appearing on the display). Displays current heater temperature setting. Use the Temp Up/Down icon to change the heater temperature setting. • Heat Off Press to turn heat Off (indicated by 1 short beep). ! NOTE: After the heater is switched off, the fan will continue on for 60 seconds before turning off.
Control Lock			Hold both Temp- () and Brightness (), on the unit, for 2 seconds to disable the manual controls.
Control Unlock			Hold both Temp- () and Brightness (), on the unit, for 2 seconds to enable the manual controls.

Maintenance

General Maintenance

Inspect the built-in electric firebox regularly, depending upon conditions, and at a minimum yearly intervals. Remove dust and clean the logs, grate, and base as required.

⚠ WARNING: Disconnect power and allow heater to cool before attempting any maintenance or cleaning to reduce the risk of fire, electric shock, or injury.

⚠ CAUTION: Except for installation and cleaning described in this manual, an authorized service representative should perform any other servicing.

Clean Logs and Base

The built-in electric firebox set should not be operated with an accumulation of dust or dirt on or in the firebox, as this can cause a build up of heat and eventual damage.

Dust and vacuum the firebox as needed. Use a damp cloth and a mild detergent to clean painted surfaces of the built-in electric firebox. Never use abrasive cleaners.

Clean Reflector Screen

The reflector screen is cleaned in the factory during the assembly operation. During shipment, installation, handling, etc., the screen may collect dust particles; these can be removed by dusting lightly with a clean dry cloth.

To remove fingerprints or other marks, clean the reflector screen damp cloth. Never use abrasive cleaners. Dry the screen completely with a lint free cloth to prevent water spots.

Remote Battery Replacement

To replace the battery:

1. Push down on the battery cover located on the back of the remote control. Slide the battery cover open.
2. Install 3V (CR2032) Lithium battery in the battery holder. The positive (+) side of the battery faces up.
3. Close the battery cover.



The old battery must be recycled or disposed of properly. Check with your Local Authority or Retailer for recycling advice in your area.

⚠ CAUTION: When transporting or storing the heater and cord, keep in a dry place, free from excessive vibration and store so as to avoid damage.

Exploded Parts Diagram - RBF24DLX

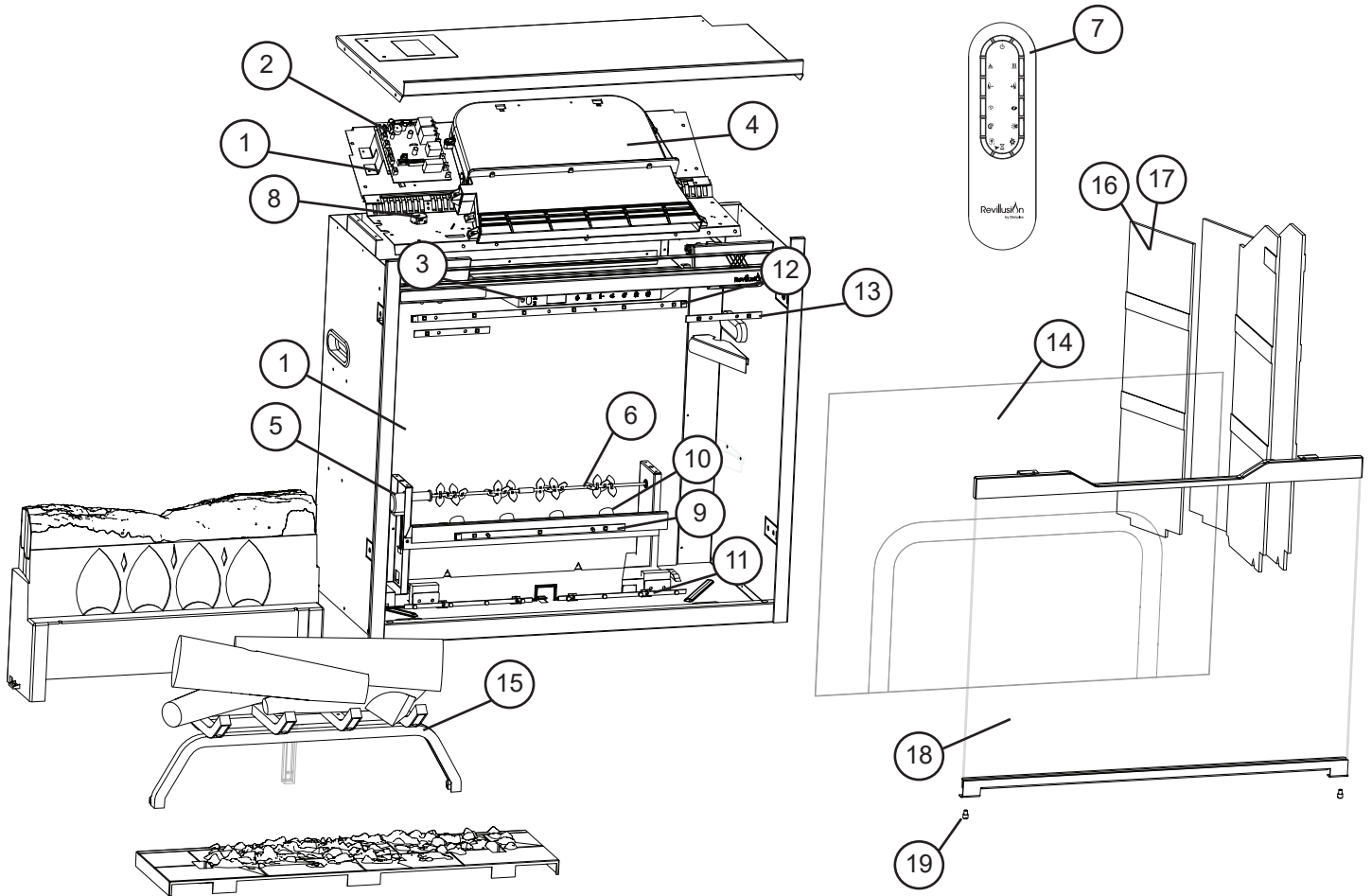

Replacement Parts List

1. Power Supply	2100250600RP	11. Ember LED	3001820100RP
2. Main Control Board	3002080101RP	12. Top Back Light (RGB).	3001570100RP
3. Touch pad	3001830200RP	13. Top Front Lights (2 sets).	3001570600RP
4. Heater Assembly	2203810100RP	14. Flame Screen	5903010200RP
5. Flicker Motor.	3000240200KIT	15. Log Set Assembly.	0442400100RP
6. Flicker Rod	5903040200RP	16. Brick Panels (LH & RH)	5903200001RP
7. Remote Control	3001970100RP	17. Weather Concrete Panels (LH & RH).	5903201001RP
8. Thermistor	0442570100RP	18. Front Glass	6909870500RP
9. Flame Base (RGB).	3001790100RP	19. Front Glass Hardware	9601750100RP
10. Flame/Back Log LED	3001760200RP	20. Power Cord	RBFPLUG

Wiring Diagram - RBF30, RBF36, RBF36P, RBF42

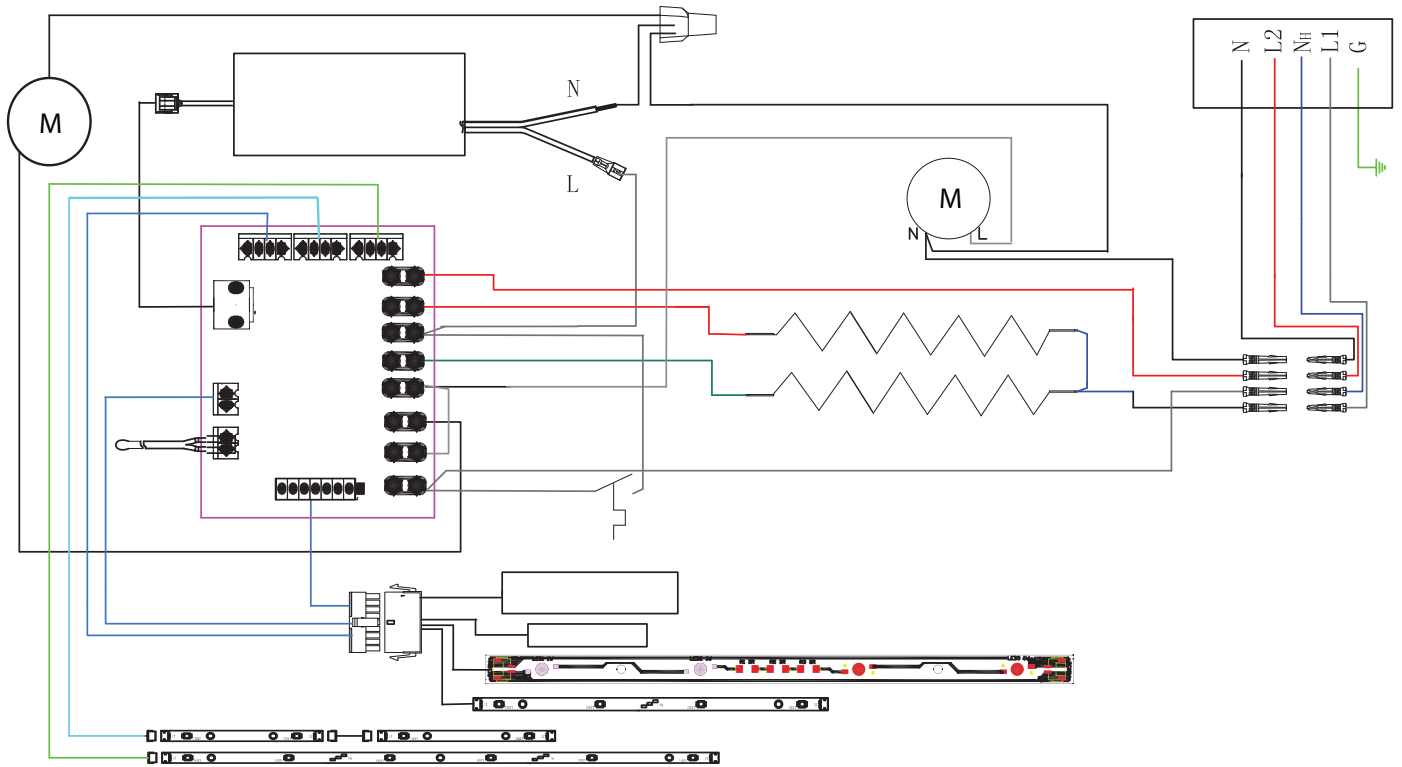

Wiring Diagram - RBF24DLX

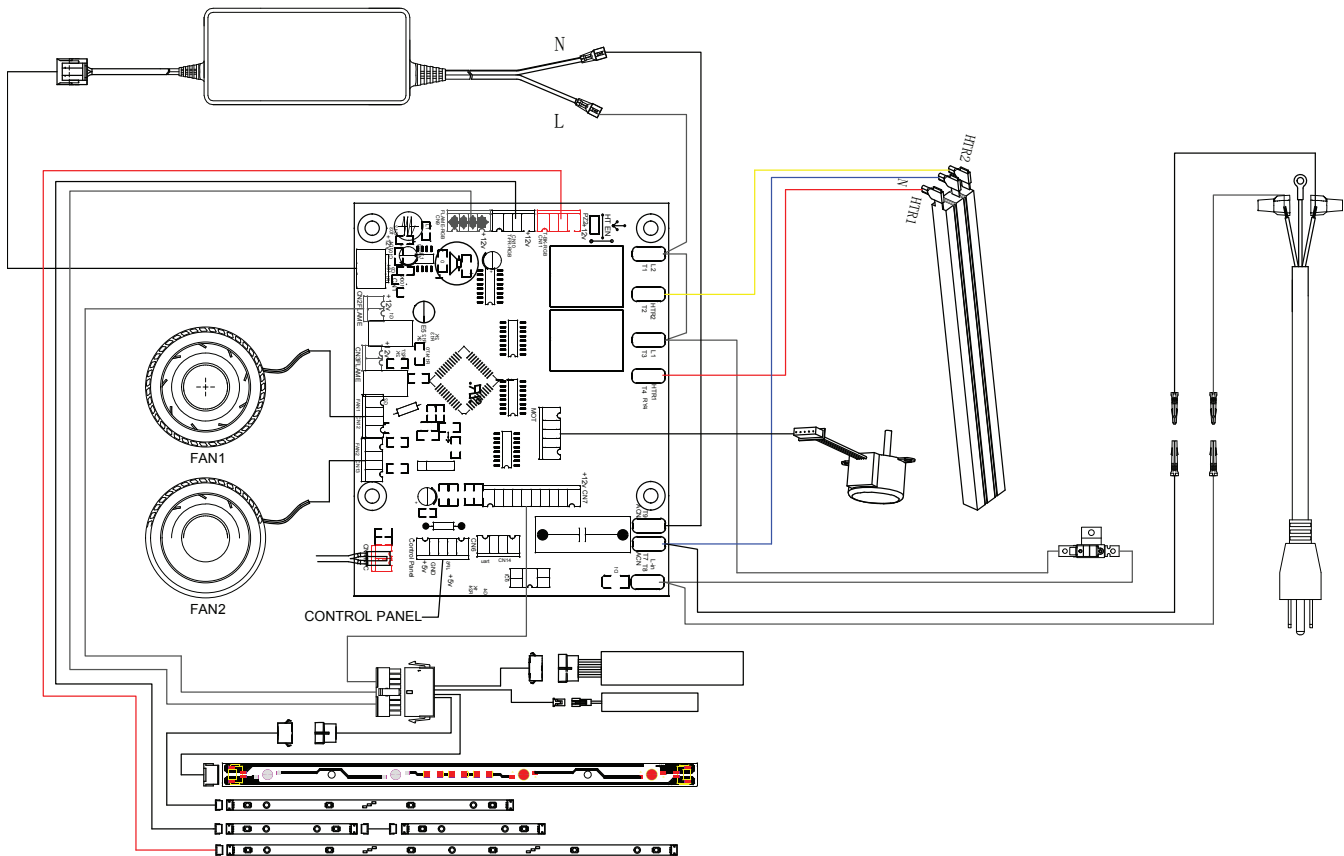

Preparing for Service

Tools Required: Phillips head screwdriver

⚠ WARNING: If the firebox was operating prior to servicing, allow at least 10 minutes for the heating elements to cool off to avoid accidental burning of skin.

⚠ WARNING: Disconnect power before attempting any maintenance to reduce the risk of electric shock or damage to persons.

1. Unplug the fireplace or turn off the breaker to disconnect the power.
2. Remove the front glass.
3. Locate and remove the screw behind each of the front legs of the firebox (2 screws total). (Figure 3)

! IMPORTANT: Only handle the log set by the plastic grate, not the logs themselves.

4. Slide the log set assembly forward and lift the log set assembly and the ember mat out. (Figure 3)

! NOTE: If using the original log set assembly, it must be unplugged to remove it.

5. On either side of the firebox gently remove the decorative panels by placing your finger in the gap toward the back and pulling out. The decorative panels are held in place by magnets and need minimal force to be removed.
6. Locate the two brackets securing the flame panel in the unit at the bottom and remove the 4 screws. (Figure 3)
7. Gently lift the flame panel out, and set it aside in a safe location.

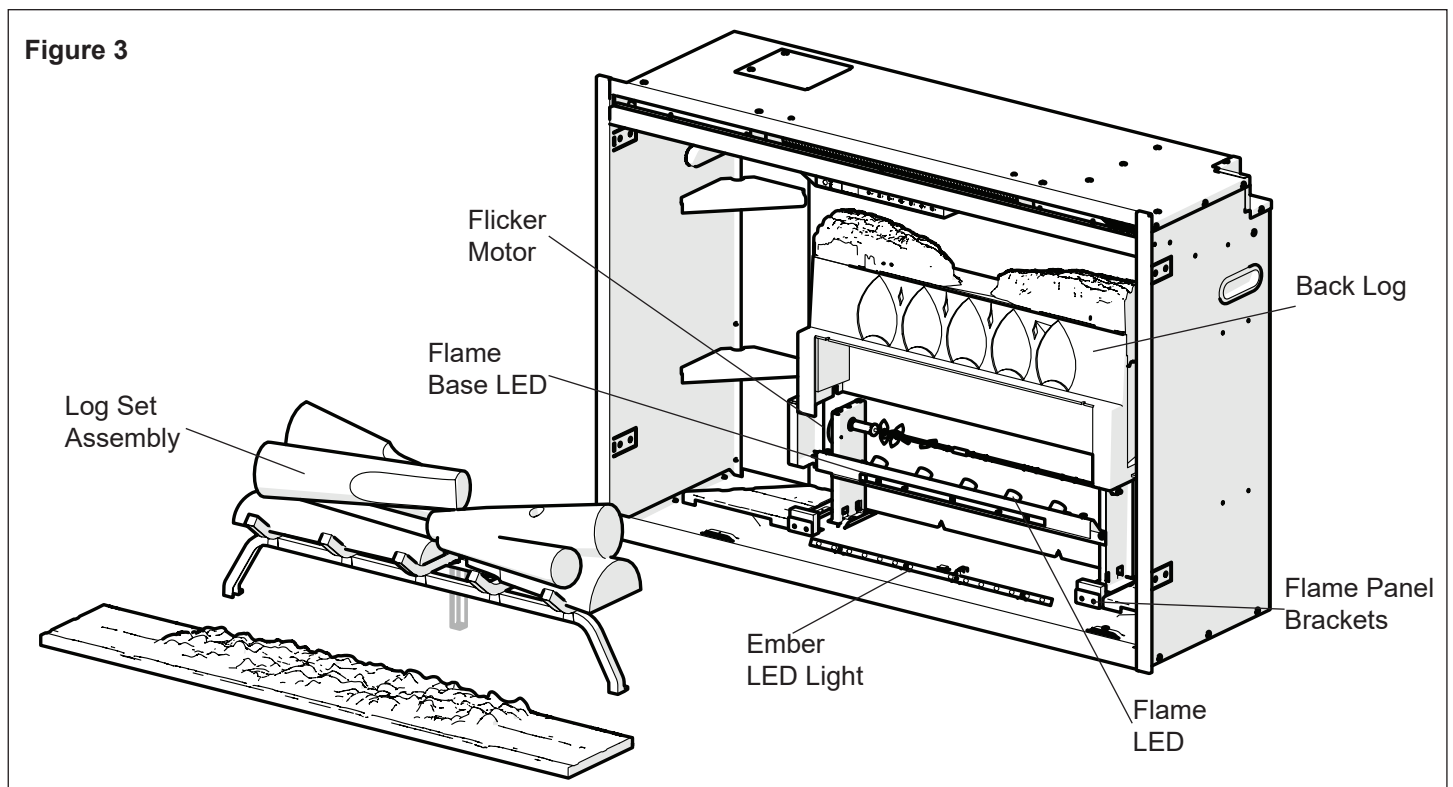

Ember LED Light Replacement

Tools Required: Phillips head screwdriver
Needle-nose pliers

1. Follow steps 1-4 of ‘Preparing for Service’ on page 8.
2. Locate the two ember LED light assemblies and the connector on the left hand side. (Figure 3)
3. Disconnect the connector.
4. Squeeze the mounting tabs located along the board with the needle-nose pliers, to release the tabs and lift off.
5. Replace the LED light assembly with the new assembly, and connect the connector into the side marked “IN”.
6. Reassemble the unit in reverse order from the instructions above.

Flame Base LED Replacement

Tools Required: Phillips head screwdriver

1. Follow the steps of ‘Preparing for Service’ on page 8.
2. Remove the back log assembly by removing the two screws along the front of the log and the screw on either end.
3. Lift the back log assembly out of the unit.
4. Locate the flame base LED strip. (Figure 3)
5. Remove the flame base LED strip by pressing in the tab in the center of the standoffs to release the center pin out the back and lift the light strip off.
6. Disconnect the light strip by pulling the connector out of the assembly on the left hand side.
7. Connect the new light strip, ensuring the side marked “IN” is on the left hand side.
8. Reassemble the unit in reverse order from the instructions above.

Flame LED Replacement

Tools Required: Phillips head screwdriver

1. Follow the steps of ‘Preparing for Service’ on page 8.
2. Remove the back log assembly by removing the two screws along the front of the log and the screw on either end.
3. Lift the back log assembly out of the unit.
4. Locate the flame LED strip. (Figure 3)
5. Remove the flame LED strip by pinching the standoffs while lifting the light strip off.
6. Disconnect the light strip by pulling the connector out of the assembly on the left hand side.
7. Connect the new light strip, ensuring the side marked J1 is on the left hand side.
8. Reassemble the unit in reverse order from the instructions above.

Flicker Motor Replacement (RBF30, RBF36, RBF36P, RBF42)

Tools Required: Phillips head screwdriver

1. Follow the steps of ‘Preparing for Service’ on page 8.
2. Remove the back log assembly by removing the two screws along the front of the log and the screw on either end.
3. On the left hand side, locate the motor cover and remove the two screws securing it to the firebox. The cover can be gently tilted back and lifted out to access the wire connections. (Figure 3)
4. Remove the two screws that secure the motor to the unit.
5. Disconnect the flicker rod and rubber grommet from the flicker motor.
6. Disconnect the wire connectors, noting the location of the wires and connect the new motor wires.
7. Reassemble the unit in reverse order from the instructions above.

⚠ WARNING: Ensure wires do not get pinched while reinstalling the motor cover.

Flicker Motor Replacement (RBF24DLX)

Tools Required: Phillips head screwdriver
Wire Snips

1. Follow the steps of ‘Preparing for Service’ on page 8.
2. Remove the back log assembly by removing the two screws along the front of the log and the screw on each side (4 total).
3. Pull the flicker motor out from the rubber coupling attached to the flicker rod.
4. Remove the two screws that affix the flicker motor to the bracket.
5. Cut the five wires as close as possible to the flicker motor.
6. Cut wire leads from the new flicker motor to 3 1/2 inches long.
7. Using one of the supplied wire connectors, connect the yellow wire from the new flicker motor with the yellow wire cut from the old flicker motor.
8. Secure the wire connector by crimping the 3M symbol with pliers. Pull on both wires to ensure a strong connection.
9. Repeat the process for the 4 remaining wires, ensuring that all wires are paired by colour in each connector.
10. Attach new flicker motor to the retaining bracket.
11. Insert stem from flicker rod into the rubber grommet.
12. Reassemble fireplace

⚠ WARNING: Ensure wires do not get pinched while reinstalling the motor cover.

Main Control Board Replacement

Tools Required: Phillips head screwdriver
Flat Head Screwdriver

1. Follow the steps of 'Preparing for Service' on page 8.
 2. Remove the 2 hex head screws on either side of the controls and the 4 hex head screws (12 screws total) along each side of the panel and gently lower the internal assembly. (Figure 4)
 3. Disconnect the two main wire connectors - one on each side of the unit.
 4. Disconnect the hanging straps at the front, ensuring that you support the entire assembly, and lift the back of the assembly up and off of the hook at the back. At this point you should be able to gently set the assembly on the surface in front of the unit to access the main control board.
 5. Transfer the wire connectors from the terminals on the original board to the same location on the replacement board, cutting the cable ties as necessary. (Figure 4)
- !** **NOTE:** Use a flat head screwdriver to gently pry between the end of the connector and the main control board to release the wires.
6. Remove the screws in each of the corners of the board and lift the board off. (Figure 5)
 7. Install the new board.
 8. Reassemble the remainder of the firebox in reverse order from the instructions above.

⚠ WARNING: Ensure wires do not come in contact with moving parts by securing wires in cable ties.

Power Supply Replacement

Tools Required: Phillips head screwdriver

1. Follow the steps of 'Preparing for Service' on page 8.
2. Remove the 2 hex head screws on either side of the controls and the 4 hex head screws (12 screws total) along each side of the panel and gently lower the internal assembly. (Figure 4)
3. Disconnect the two main wire connectors - one on each side of the unit.
4. Disconnect the hanging straps at the front, ensuring that you support the entire assembly, and lift the back of the assembly up and off of the hook at the back. At this point you should be able to gently set the assembly on the surface in front of the unit to access the power supply.
5. Locate the power supply located below the main control board. (Figure 4)
6. Remove the 4 screws that secure the main control board to the unit. (Figure 5)
7. Remove the 4 screws on the assembly to release the bracket that secures the power supply to the unit. (Figure 6)
8. Trace the wires to the main control board and the wire nuts and replace the old connections with the new connections, cutting the cable ties as necessary.
9. Reinstall the support bracket over the new power supply.
10. Reassemble the remainder of the firebox in reverse order from the instructions above.

⚠ WARNING: Ensure wires do not come in contact with moving parts by securing wires in cable ties.

Figure 4

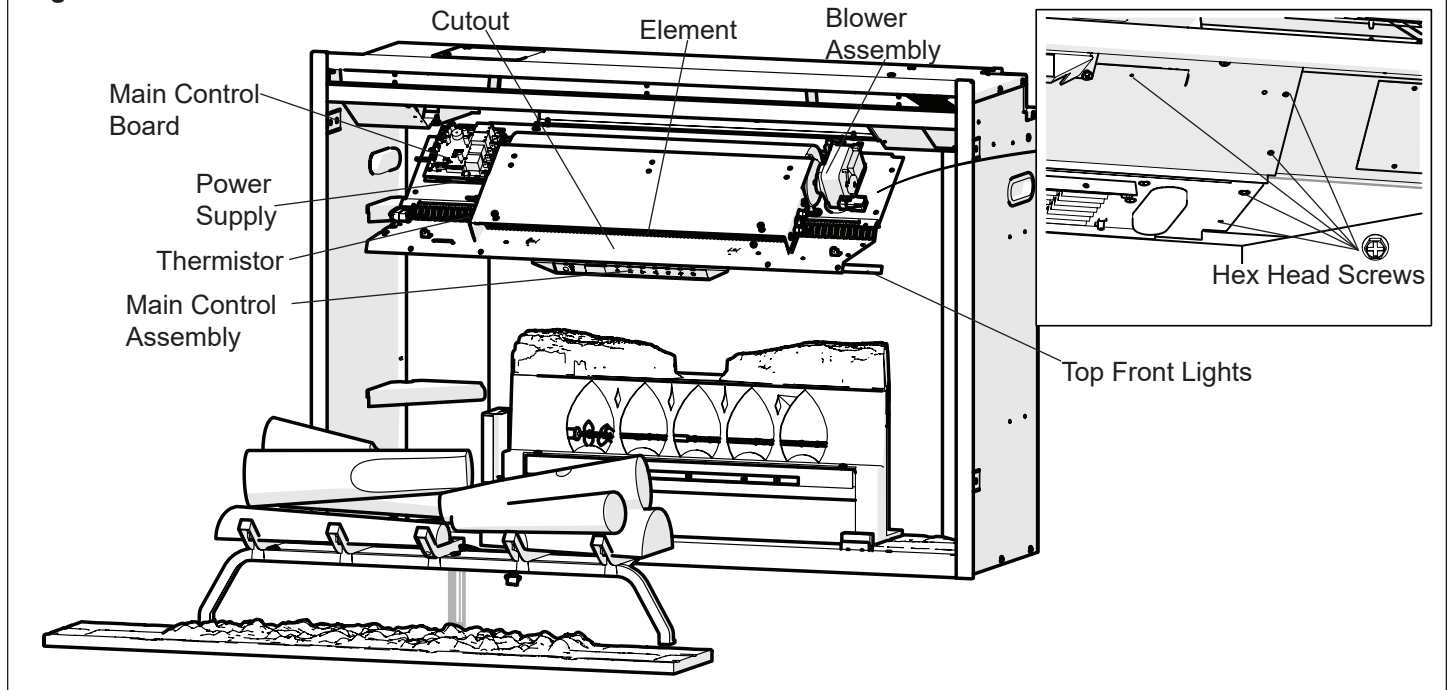

Blower Assembly Replacement (RBF30, RBF36, RBF36P, RBF42)

Tools Required: Phillips head screwdriver
Flat Head Screwdriver

1. Follow the steps of 'Preparing for Service' on page 8.
2. Remove the 2 hex head screws on either side of the controls and the 4 hex head screws (12 screws total) along each side of the panel and gently lower the internal assembly. (Figure 4)
3. Disconnect the two main wire connectors - one on each side of the unit.
4. Disconnect the hanging straps at the front, ensuring that you support the entire assembly, and lift the back of the assembly up and off of the hook at the back. At this point you should be able to gently set the assembly on the surface in front of the unit to access the blower assembly.
5. From the top panel of the heating assembly housing, locate and remove the 6 screws that hold the blower assembly to the housing panel. Separate the blower assembly from the housing panel. (Figure 4)

⚠ CAUTION: When removing the blower assembly mounting screws support the assembly to prevent any damage to the unit.

6. Disconnect the wiring connections noting their original locations.

! NOTE: Using a flat head screwdriver, gently pry between the end of the connectors and the blower/fan to release the wires.

7. Properly orient the new blower assembly and connect all of the wiring connections.
8. Reassemble the remainder of the firebox in reverse order from the instructions above.

⚠ WARNING: Ensure wires do not come in contact with moving parts by securing wires in cable ties.

Element Replacement (RBF30, RBF36, RBF36P, RBF42)

Tools Required: Phillips head screwdriver
Flat Head Screwdriver

1. Follow the steps of 'Preparing for Service' on page 8.
2. Remove the 2 hex head screws on either side of the controls and the 4 hex head screws (12 screws total) along each side of the panel and gently lower the internal assembly. (Figure 4)
3. Disconnect the two main wire connectors - one on each side of the unit.
4. Disconnect the hanging straps at the front, ensuring that you support the entire assembly, and lift the back of the assembly up and off of the hook at the back. At this point you should be able to gently set the assembly on the surface in front of the unit to access the element.
5. From the top panel of the heating assembly housing, remove the 4 screws that hold the element cover to the housing panel. (Figure 4)
6. Disconnect wires from the ends of the elements noting their original locations.

! NOTE: Using a flat head screwdriver, gently pry between the end of the connectors and the element to release the wires.

! NOTE: Some of the wires may have a "piggy-back" connector that allows a second wire to connect to the same prong as the first wire. Try and keep the "piggy-back" connection together when pulling the wires off the element.

7. Using a 3/8" ratchet or wrench remove the hex head screw from both sides of the element. Remove elements from the element housing and replace with the new elements.
8. Reassemble the remainder of the firebox in reverse order from the instructions above.

⚠ WARNING: Ensure wires do not come in contact with moving parts by securing wires in cable ties.

Cutout Replacement (RBF30, RBF36, RBF36P, RBF42)

Tools Required: Phillips head screwdriver
Flat Head Screwdriver

1. Follow the steps of 'Preparing for Service' on page 8.
2. Remove the 2 hex head screws on either side of the controls and the 4 hex head screws (12 screws total) along each side of the panel and gently lower the internal assembly. (Figure 4)
3. Disconnect the two main wire connectors - one on each side of the unit.
4. Disconnect the hanging straps at the front, ensuring that you support the entire assembly, and lift the back of the assembly up and off of the hook at the back. At this point you should be able to gently set the assembly on the surface in front of the unit to access the upper components.
5. Remove the 3 heater assembly mounting screws from underneath the top panel along the front. (Figure 4)
6. Lower the heater assembly so that the 3 support tabs, in the top panel, can be easily released.
7. Remove temperature limit switch screw from heater bracket assembly and disconnect the temperature limit switch wire from heater element and from the wire connectors, noting their original location.
8. Properly orient the new temperature limit switch and secure it to the heater bracket assembly with the small screw from the original cutout.
9. Reconnect the wires in their original locations.
10. Reassemble the remainder of the firebox in reverse order from the instructions above.

⚠ WARNING: Ensure wires do not come in contact with moving parts by securing wires in cable ties.

Heater Assembly Replacement (RBF24DLX)

Tools Required: Phillips head screwdriver
Flat Head Screwdriver

1. Follow the steps of 'Preparing for Service' on page 8.
2. Remove the 2 hex head screws on either side of the controls and the 4 hex head screws (12 screws total) along each side of the panel and gently lower the internal assembly. (Figure 4)
3. Disconnect the two main wire connectors - one on each side of the unit.
4. Disconnect the hanging straps at the front, ensuring that you support the entire assembly, and lift the back of the assembly up and off of the hook at the back. At this point you should be able to gently set the assembly on the surface in front of the unit to replace the heater assembly.
5. Remove the two screws securing the heater assembly to the top panel from the inside. (Figure 5)
6. Remove the 4 screws from the outer side of the top panel that secure the heater assembly brackets to the top panel. (Figure 6)
7. Remove the 2 screws on each bracket that secure the brackets to the heater assembly (4 screws total).
8. Remove the wire connections from the heater assembly, making note of their original locations. Cut the cable ties as necessary.
9. Connect the wires from the new heater assembly.
10. Secure the previously removed brackets to the new heater assembly.
11. **! NOTE:** Using a flat head screwdriver, gently pry between the end of the connectors and the blower/fan to release the wires
12. Secure the brackets to the top panel, using the screws removed in step 6.
13. Reassemble the remainder of the firebox in reverse order from the instructions above.

Figure 5

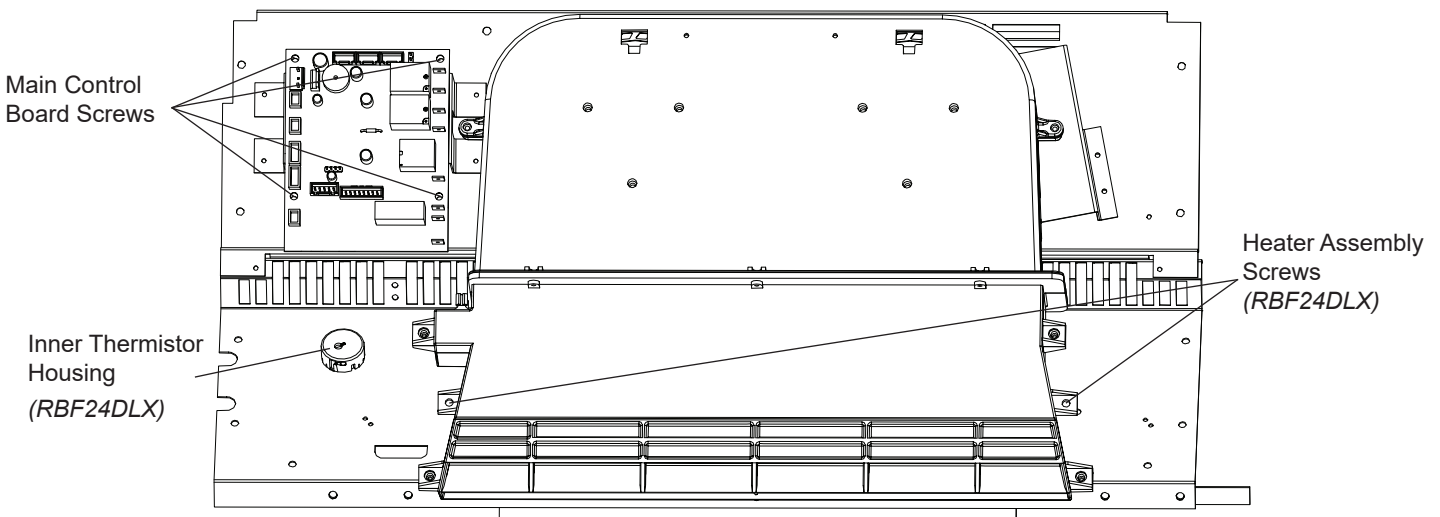

Touch Pad Replacement

Tools Required: Phillips head screwdriver

⚠ WARNING: If the firebox was operating prior to servicing, allow at least 10 minutes for the heating elements to cool off to avoid accidental burning of skin.

⚠ WARNING: Disconnect power before attempting any maintenance to reduce the risk of electric shock or damage to persons.

1. Unplug the fireplace or turn off the breaker to disconnect the power.
2. Remove the front glass.
3. Remove the two screws on each side of the touch pad assembly.
4. Unplug the pin connector.
5. Plug in the connector from the new touch pad.
6. Install the replacement control assembly and secure with the 4 screws that were previously removed.
7. Reinstall the front glass.

Thermistor Replacement (RBF24DLX)

Tools Required: Phillips head screwdriver

1. Follow the steps of 'Preparing for Service' on page 8.
2. Remove the 2 hex head screws on either side of the controls and the 4 hex head screws (12 screws total) along each side of the panel and gently lower the internal assembly. (Figure 4)
3. Disconnect the two main wire connectors - one on each side of the unit.
4. Disconnect the hanging straps at the front, ensuring that you support the entire assembly, and lift the back of the assembly up and off of the hook at the back. At this point you should be able to gently set the assembly on the surface in front of the unit to replace the heater assembly.
5. Trace the thermistor wire back to the main board, cutting the cable ties as necessary. Unplug the defective thermistor.
6. Hold the top and bottom parts of the thermistor housing, twisting them until they come apart. (Figures 5 and 6)
7. Remove the thermistor from the thermistor housing.
8. Insert the new thermistor into the thermistor housing.
9. Secure the thermistor housing to the top panel.
10. Connect the new thermistor to the main control board.
11. Reassemble the remainder of the firebox in reverse order from the instructions above.

Figure 6

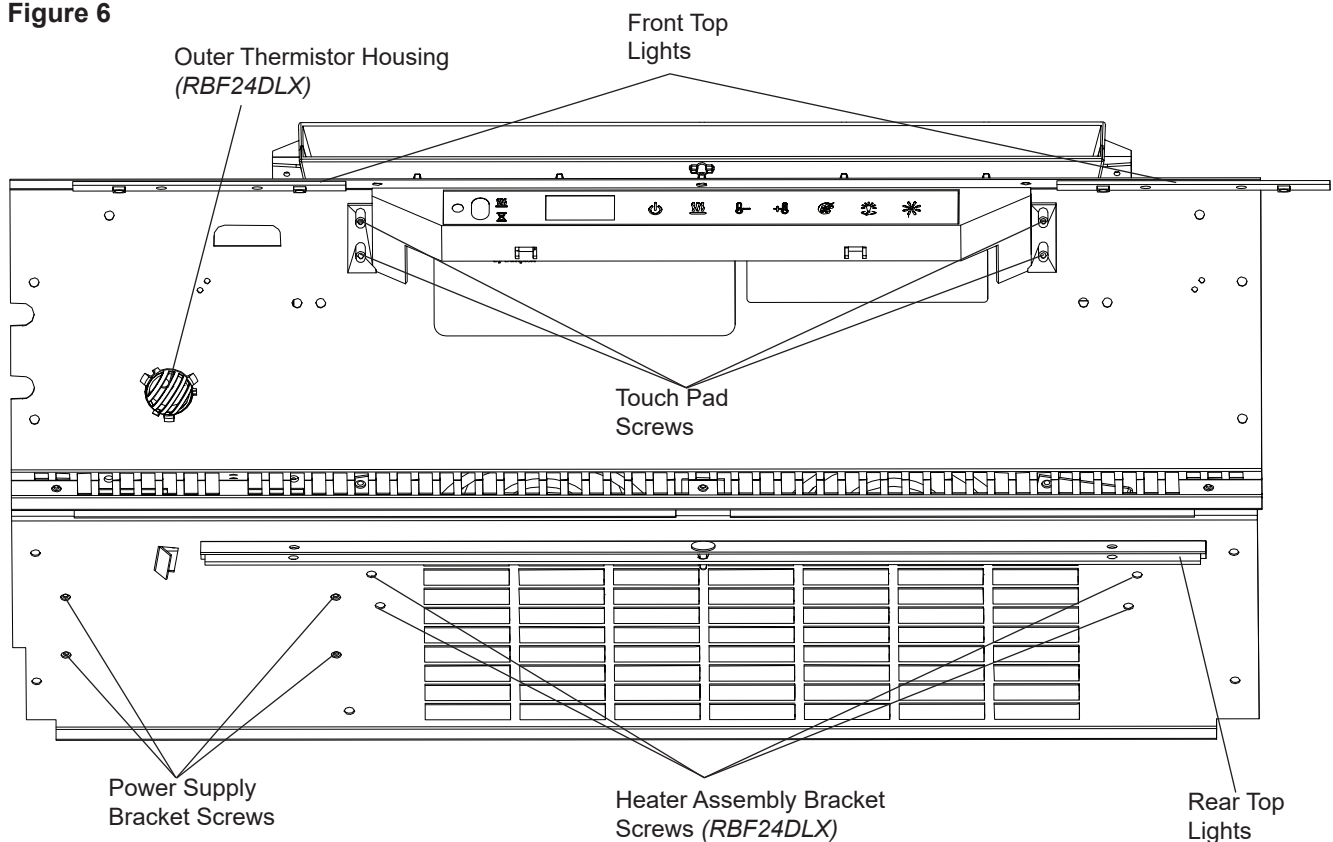

Thermistor Replacement (RBF30, RBF36, RBF36P, RBF42)

Tools Required: Phillips head screwdriver

1. Follow the steps of 'Preparing for Service" on page 8.
2. Remove the 2 hex head screws on either side of the controls and the 4 hex head screws (12 screws total) along each side of the panel and gently lower the internal assembly. (Figure 4)
3. Disconnect the two main wire connectors - one on each side of the unit.
4. Disconnect the hanging straps at the front, ensuring that you support the entire assembly, and lift the back of the assembly up and off of the hook at the back. At this point you should be able to gently set the assembly on the surface in front of the unit to replace the thermistor.
5. Locate the thermistor and tie wrap securing it to the standoff. (Figure 4)
6. Trace the wire from the thermistor to the main control board and disconnect the wire, noting the location on the board.
7. Run the wire from the thermistor, following the same path as the wire that was removed. Attach the new wire to the board.
8. Install the replacement thermistor and secure.
9. Reassemble the remainder of the firebox in reverse order from the instructions above.

Top Front Lights Replacement

Tools Required: Phillips head screwdriver

1. Follow the steps of 'Preparing for Service" on page 8.
2. Remove the 2 hex head screws on either side of the controls and the 4 hex head screws (12 screws total) along each side of the panel and gently lower the internal assembly. (Figure 4)
3. Locate the defective front top light assembly. From the backside of the standoff press the center out to release the center pin and remove the light assembly. (Figure 4)
4. Disconnect the connection on each end, noting which end is labeled "IN" and which is labeled "OUT".
5. Orient and place the new LED strip, using the previously removed pin to secure it to the top panel.
6. Reassemble the remainder of the firebox in reverse order from the instructions above.

Rear Top Lights Replacement

Tools Required: Phillips head screwdriver
Needle nose pliers

1. Follow the steps of 'Preparing for Service" on page 8.
2. Locate the rear top light assembly and use the pliers to pinch the back of the standoffs while pulling the LED away to release the light assembly.
3. Disconnect the connection.
4. Properly orient the LED strip, ensuring that the end labeled "IN" is toward the left, so that it can receive the connection.
5. Reassemble the remainder of the firebox in reverse order from the instructions above.

Troubleshooting Guide

PROBLEM	CAUSE	SOLUTION
General		
Circuit breaker trips or fuse blows when unit is turned on	Improper circuit current rating	Additional appliances may exceed the current rating of the circuit breaker or fuse. Plug unit into another outlet or install unit on a dedicated 15 amp circuit.
	Short in unit wiring.	Trace wiring in unit.
Lights dim in room while the unit is on	Unit is drawing close to circuit current rating	Move the unit to another outlet or install unit on a dedicated 15 amp circuit
Power cord gets warm	Normal Operation	The power cord may get slightly warm to the touch when the heater is on
	Defective power cord	Replace power cord if cord gets hot to the touch.
Appearance		
Firebox does not turn on in Manual Mode	Improper operation	Refer to Operation section
	No incoming power from the electrical wall socket	Check fuse/breaker panel
	Defective touch pad	Replace touch pad
	Defective main control board	Replace main control board.
Firebox does not turn on in Remote Mode	Improper operation	Refer to Operation section
	Loose wiring	Check wiring connections
	Remote control not working	Replace batteries. Replace remote control if defective.
	Defective touch pad	Replace touch pad
	Defective main control board	Replace main control board
One or all logs in log set dim, not glowing	Loose connection	Check wiring connections
	Defective log set	Replace log set
Back log dim, not glowing	See below "Flame not appearing"	
Flame dim or not appearing	Improper operation	Refer to Operation section
	Loose connection of flame LEDs	Check wiring connections
	Defective flame LED wiring	Replace flame LED strip
	Defective main control board	Replace main control board.
Flame Frozen	Loose wiring	Check wiring connections
	Defective flicker motor	Replace flicker motor
Flame Shudder	Defective flicker motor	Replace flicker motor
Colour themes dim or not appearing	Improper operation	Refer to Operation section
	Loose connection of coloured LEDs	Check wiring connections
	Defective coloured LED wiring	Replace affected coloured LED strip
	Defective main control board	Replace main control board.

REV	PCN	DATE
01	-	5-Sept-18
02	-	11-Feb-20

PROBLEM	CAUSE	SOLUTION
Heater		
Heater is not turning Off	Normal operation	The fan will continue to run for 60 seconds after heat has been turned off.
	Defective main control board	Replace main control board
Heater is not turning On	Improper operation	Refer to Operation section Ensure that heat is not disabled (--- is displayed) Ensure set temp. is higher than room temperature
	Improper wiring/installation	Refer to installation guide
	Defective blower ¹	Replace blower ¹
	Defective heater assembly ²	Replace heater assembly ²
Heater is turning off after a couple of minutes of operation	Build up of dirt/dust	Ensure that exterior intake louvers and firebox cavity are free of dirt/dust.
	Defective blower ¹	Replace blower ¹
	Defective heater assembly ²	Replace heater assembly ²
Heater emits an odor	Normal Operation	Normal operation is when the heater emits an odor for a brief period after the heater is initially turned on. The heater is burning off any dust accumulated during manufacturing or operation.
Heater fan turns on but heater lacks heat	Improper operation	Refer to Operation Section
	Loose wiring	Trace wiring in unit
	Defective heater assembly ²	Replace heater assembly ²
Heating element is glowing red	Normal Operation	Small glowing sections of the element are considered normal.
	Defective blower ¹	If larger glowing sections are causing the heater to trip the thermal cutout, unplug unit, discontinue use and replace blower/heater assembly.
	Defective heater assembly ²	
Heater fan runs continuously	Defective main control board	Replace main control board
Noise		
Excessive noise with the heater on	Dirty blower/heater assembly	Ensure that exterior intake louvers and firebox cavity are free of dirt/dust.
	Defective blower ¹	Replace blower ¹
	Defective heater assembly ²	Replace heater assembly ²
Excessive noise with the heater off	Defective flicker motor	Replace flicker motor
Error Codes		
E 1	Defective/disconnected thermistor	Replace thermistor
E 2	Heater is cutting out	Ensure installation is not sub-recessed and that proper airflow is achieved
		Replace heater or blower if needed
E--	Heat has been permanently disabled.	Reinsert shunt if possible or replace main control board.

¹ Only applicable to units RBF30, RBF36, RBF36P, and RBF42

² Only applicable to RBF24DLX

1-888-346-7539 | www.dimplex.com

In keeping with our policy of continuous product improvement, we reserve the right to make changes without notice.

© 2020 Glen Dimplex Americas

Glen Dimplex
AMERICAS
Enhancing the moments that matter in life