

ORION SLIM WALL-MOUNT/RECESSED ELECTRIC FIREPLACE
Model #: ■ OR52-SLIM ■ OR60-SLIM ■ OR76-SLIM ■ OR100-SLIM

OWNER'S MANUAL

MODERN  FLAMES

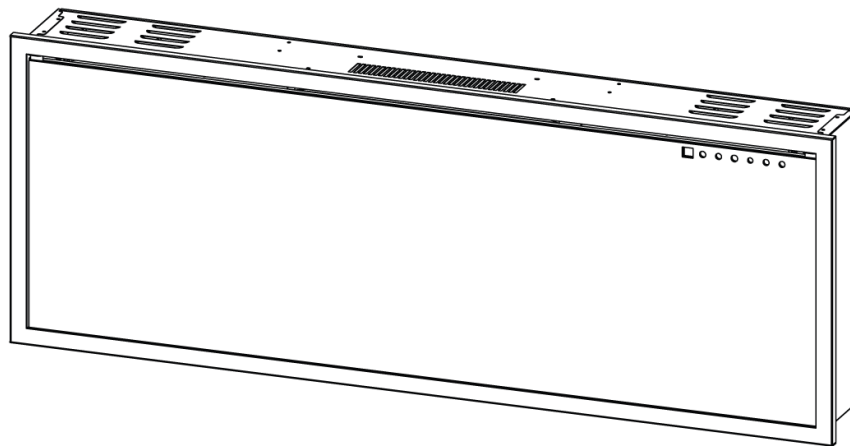

AC 120V 60Hz 1465W (5000BTUs)



Read and understand this entire owner's manual, including **all safety information**, before plugging in or **using** this product. Failure to do so could result in **fire, electric shock, or serious personal injury**.



Keep this owner's manual for future reference. If you sell or give this product away, **make sure this manual accompanies this product**.

AFFIX SERIAL NUMBER LABEL HERE
FOR FUTURE REFERENCE





IMPORTANT SAFETY INFORMATION!

- Read all instructions before installing or using this heater.
- **Use a dedicated 20 Amp (or higher) breaker.**
- This heater is hot when in use. To avoid burns, DO NOT let bare skin touch hot surfaces. If provided, use handles when moving this heater. Keep combustible materials, such as furniture, pillows, bedding, papers, clothes, and curtains at least 3 feet (0.9m) from the front of the heater and keep them away from the sides and rear.
- Extreme caution is necessary when any heater is used by or near children or invalids and whenever the heater is left operating and unattended.
- Do not operate any heater if it malfunctions. Disconnect power at service panel and have the heater inspected by a reputable electrician before reusing.
- To disconnect the heater, turn the controls to off, and turn off power to the heater circuit at the main disconnect panel (or operate internal disconnect switch if provided).
- Do not insert or allow foreign objects to enter any ventilation or exhaust opening as this may cause an electric shock, fire, or damage the heater.
- To prevent a possible fire, do not block air intakes or exhaust in any manner.
- A heater has hot arcing or sparking parts inside. Do not use in areas where gasoline, paint, flammable vapors, or liquids are used or stored.
- Use this heater only as described in this manual. Any other use not recommended by the manufacturer may cause fire, electric shock, or injury to persons.
- This heater may include an audible or visual alarm to warn that parts of the heater are getting excessively hot. If the alarm sounds (or illuminates), immediately turn the heater off and inspect for any objects on or adjacent to the heater that may have blocked the airflow or otherwise caused high temperatures to have occurred. **DO NOT OPERATE THE HEATER WITH THE ALARM SOUNDING (OR ILLUMINATING).**
- ALWAYS plug heaters directly into a wall outlet/receptacle. NEVER use with an extension cord or relocatable power tap (outlet/power strip).
- NEVER use this heater in bathrooms, laundry rooms, or any other location where the heater could fall into a bathtub, pool, become damp, or come in contact with water.
- AVOID FIRE! Regularly inspect all air vents to make sure they are free from dust, lint, or other blockage. Unplug the unit and clean with a vacuum ONLY. DO NOT rinse or get wet.
- ALWAYS mount to wall bracket before use. DO NOT set on the floor, or other surface, to use.
- NEVER use a wall mount bracket from another manufacturer.
- This product is not intended to be a primary heat source. It is for supplemental heat only.
- INDOOR use only! NEVER use this heater outdoors! Doing so may result in electric shock!



IMPORTANT SAFETY INFORMATION!

- ALWAYS disconnect this unit from the power supply before performing any assembly, cleaning, or before relocating the electric fireplace.
- NEVER leave this heater unattended. ALWAYS unplug this heater when not in use.
- ALWAYS store this heater in a dry location. NEVER use the fireplace if it has become wet.
- NEVER plug this heater into an outlet that is old, cracked, or has loose wires or connections. Plugging this heater into a faulty outlet could result in electric arcing within the outlet that could cause the outlet to overheat or catch fire.
- ALWAYS check your heater cord and plug connections with each use.
 - i) MAKE SURE the plug fits tightly in the outlet. Faulty wall outlet connections or loose plugs can cause the outlet to overheat.
 - ii) Heaters draw more current than small appliances. Overheating may occur even if it has not occurred with the use of other appliances.
 - iii) During use, check frequently to see if the plug outlet or face plate is HOT.
 - iv) If the outlet or face plate is HOT, discontinue use immediately and have a qualified electrician inspect and/or replace the faulty outlets.

SAVE THESE INSTRUCTIONS

Table of Contents

PREPARATION	5
PARTS AND HARDWARE	5
DIMENSIONS AND SPECIFICATIONS	6
PRODUCT DIMENSIONS	6
INSTALLATION AND ASSEMBLY	6
FRONT GLASS REMOVAL/INSTALLATION	7
WALL RECESSED FRAMING	8
FINISHED OPENING DIMENSIONS	8
WALL RECESSED INSTALLATION	9
WALL MOUNTED INSTALLATION	10
HARDWIRING INSTALLATION	11
DRIFTWOOD LOGS AND CRUSHED GLASS INSTALLATION	12
OPERATION	13
<i>Power</i>	13
<i>Master Power Switch</i>	13
OPERATION (CONTINUED)	14
<i>Methods of Operation</i>	14
OPERATION – TOUCH CONTROL PANEL	15
OPERATION – REMOTE CONTROL	16
DOWNLOAD SMART PHONE APP	18
WI-FI – INITIAL LOG-IN	19
<i>Add Manually</i>	20
<i>Auto Scan</i>	23
OPERATION – SMART PHONE APP	26
HOME SCREEN	26
FLAME STYLE OPTIONS	27
FLAME STYLE ONE/TWO/THREE COLOR MENU	28
DOWNLIGHT MENU	29
EMBER BED MENU	30
HEATER MENU	31
TIMER MENU	32
WEEKLY PROGRAM SCHEDULE MENU	33
DAILY PROGRAM SCHEDULE MENU	34
OPERATION – IMPORTANT WARNINGS	35
<i>Remote Control Battery Information</i>	35
<i>Temperature Limiting Control</i>	35
CARE – CLEANING	35
CARE – MAINTENANCE	36
<i>Electrical and Moving Parts:</i>	36
<i>Storage:</i>	36
REPLACEMENT PARTS LIST	37
TROUBLESHOOTING / FAQ	39

Preparation



This product includes a GLASS panel. Always use extreme caution when handling glass. Failure to do so could result in personal injury or property damage.

Remove all parts and hardware from the carton and place them on a clean, soft, dry surface. Parts and assembly steps are grouped for wall-hanging or recessing use. Check the parts list to make sure nothing is missing. Dispose of packaging materials properly. Please recycle whenever possible.

You will need the following tools (not included): Phillips screwdriver, stud finder, level, tape measure, electric drill, 1/4" wood drill bit, hammer.

Parts and Hardware

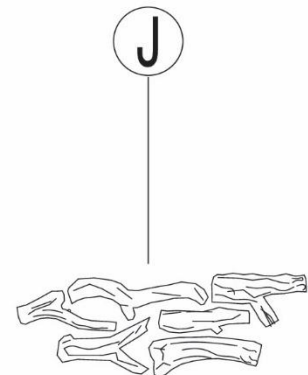
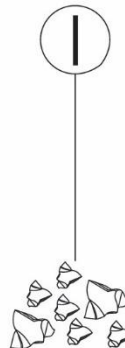
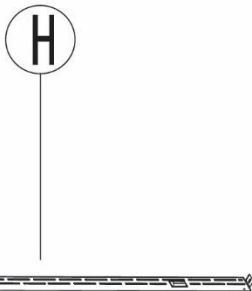
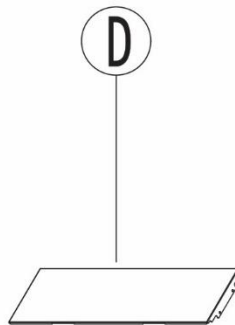
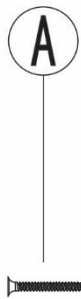

PART NO.	DESCRIPTION
A	Screws (Long)
B	Drywall Anchor
C	Screws (Short)
D	Side Skirt
E	Remote Control

PART NO.	DESCRIPTION
F	Strain Relief
G	Cover Plate
H	Wall Mount Bracket
I	Crushed Glass
J	Driftwood Logs

Dimensions and Specifications

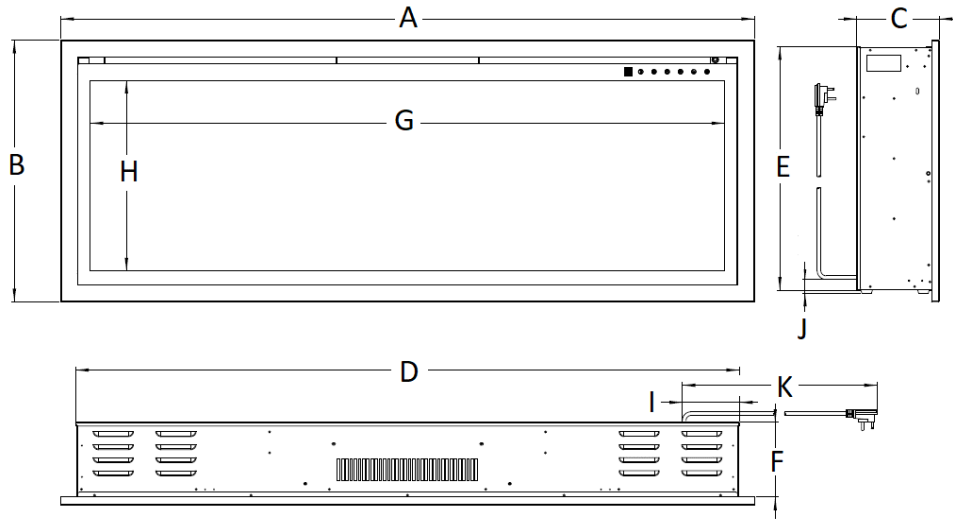

PRODUCT DIMENSIONS

Model Number	A	B	C	D	E	F	G	H	I	J	K
OR52-SLIM	52-3/8" (1330mm)	19-5/8" (499mm)	6-5/16" (160mm)	50-1/4" (1276mm)	18-3/4" (476mm)	5-3/4" (146mm)	47-7/8" (1216mm)	14-3/8" (364mm)	5" (127mm)	3/8" (10mm)	75" (1905mm)
OR60-SLIM	60" (1524mm)	19-5/8" (499mm)	6-5/16" (160mm)	58" (1473mm)	18-3/4" (476mm)	5-3/4" (146mm)	55-1/2" (1410mm)	14-3/8" (364mm)	5" (127mm)	3/8" (10mm)	75" (1905mm)
OR76-SLIM	76-5/8" (1947mm)	19-5/8" (499mm)	6-5/16" (160mm)	74-5/8" (1895mm)	18-3/4" (476mm)	5-3/4" (146mm)	72-3/16" (1833mm)	14-3/8" (364mm)	5" (127mm)	3/8" (10mm)	75" (1905mm)
OR100-SLIM	101" (2564mm)	19-5/8" (499mm)	6-5/16" (160mm)	98-7/8" (2511mm)	18-3/4" (476mm)	5-3/4" (146mm)	96-7/16" (2450mm)	14-3/8" (364mm)	5" (127mm)	3/8" (10mm)	75" (1905mm)

Installation and Assembly

Your appliance is a wall-mounted, recessed, and/or mantel installed appliance. Select a suitable location that is not susceptible to moisture and is away from drapes, furniture, and high traffic areas.

NOTE: Follow all National and local electrical codes.

MINIMUM CLEARANCE TO COMBUSTIBLES

Measurements are taken from the glass front.	
Bottom.....0"	Top (to mantel).....11.8" (300mm)
Sides.....0"	Top (to TV).....11.8" (300mm)
Back.....0"	Top (to ceiling).....11.8" (300mm)

Front Glass Removal/Installation



This product includes a GLASS panel. Always use extreme caution when handling glass. Failure to do so could result in personal injury or property damage.

- With one hand on the front glass to prevent it from falling, remove the two screws (one per side) from the side of the appliance (Fig. 1-1). Set the screws aside.
- Carefully lift the front glass up and away from the appliance (Fig. 1-2). Place it face down on a soft, non-abrasive surface.
- Reverse these steps to re-install the front glass.

Fig.1-1

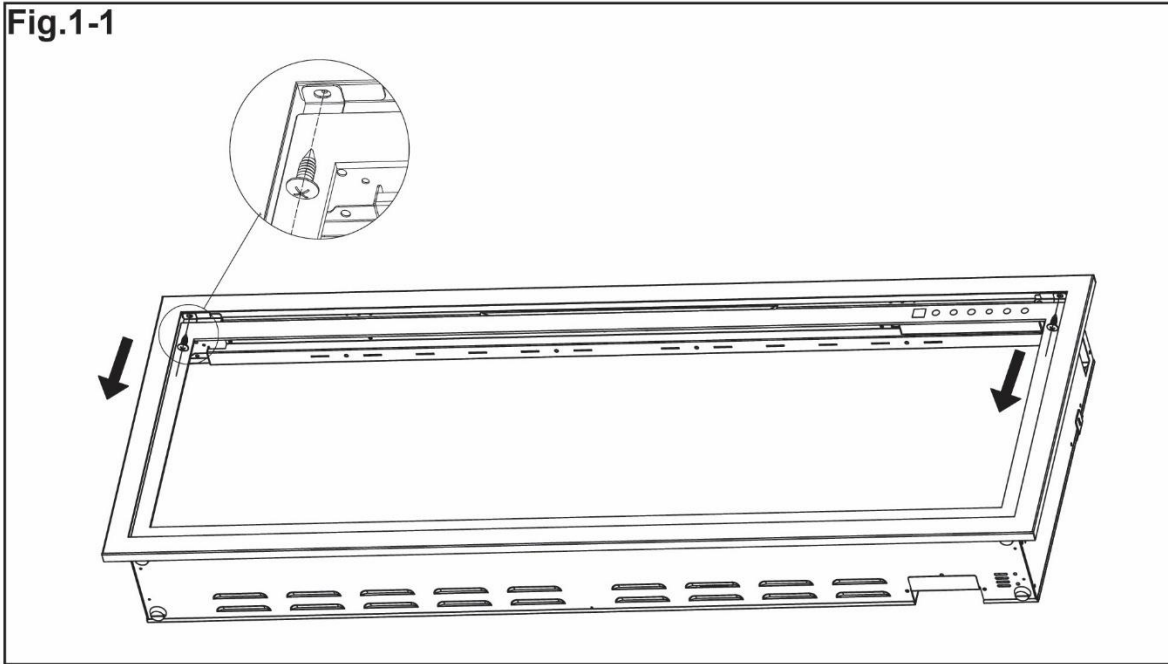
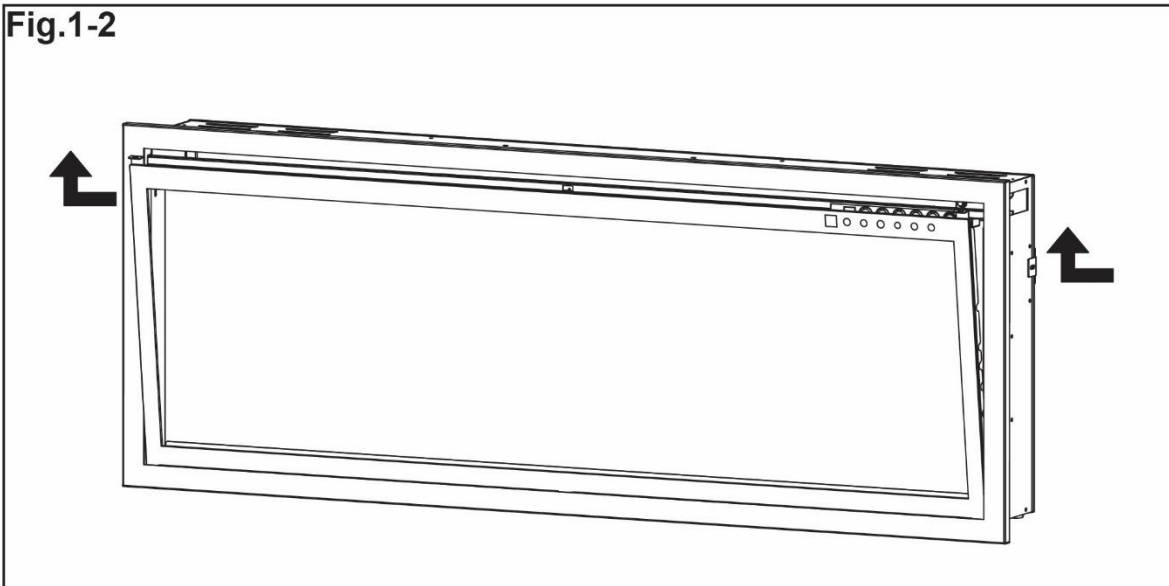

Fig.1-2



Wall Recessed Framing



Due to different materials used on different walls, it is highly recommended for you to consulting with your local builder before you install this electric fireplace.

- Select a location that is not prone to moisture and is located at least 36" (914mm) away from combustible materials such as curtain drapes, furniture, bedding, paper, etc.
- Measure the appliance and create a rough-in frame with electrical (see below).
- Remove the front glass (see "Front Glass Removal / Installation" section).
- Hold the appliance up to ensure it will fit into the framing.

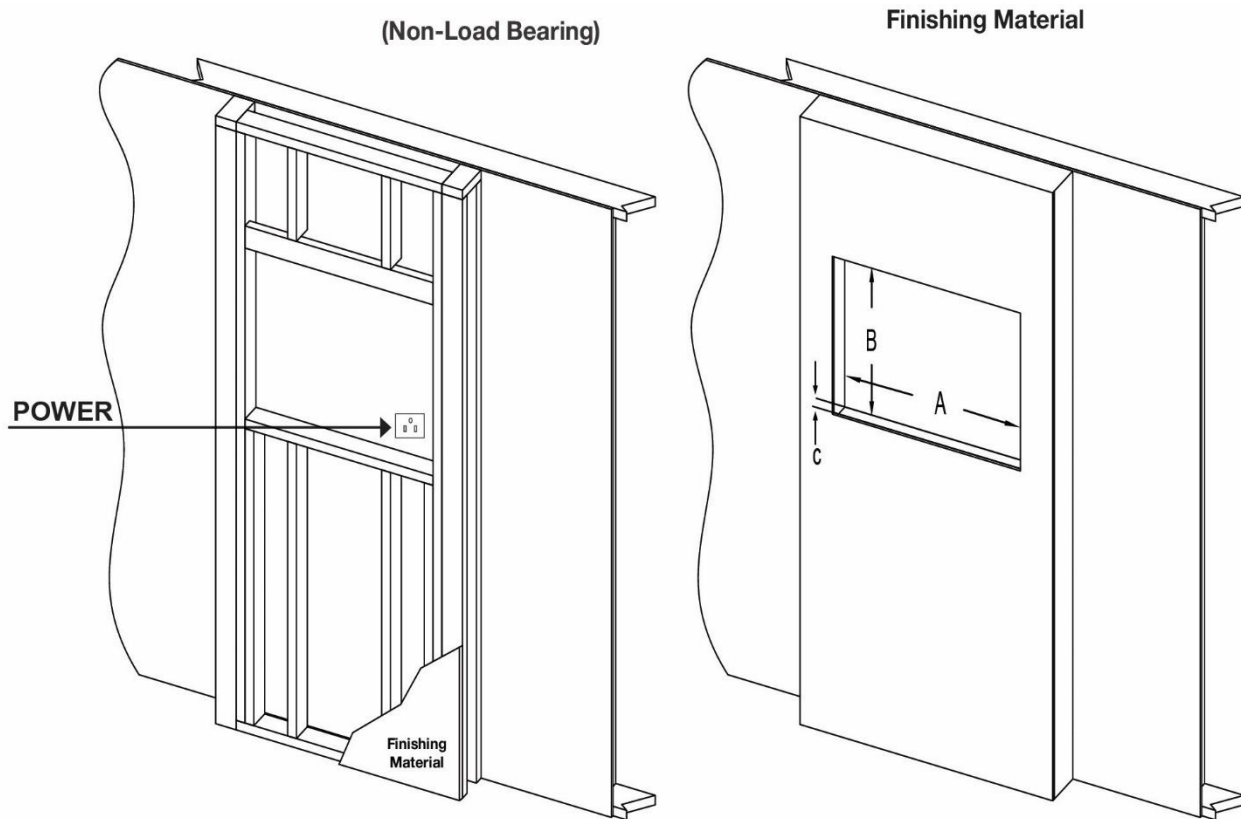

FINISHED OPENING DIMENSIONS			
Model Number	A	B	C
OR52-SLIM	50-3/4" (1289mm)	19-1/8" (486mm)	6" min. (152mm min.)
OR60-SLIM	58-1/2" (1486mm)	19-1/8" (486mm)	6" min. (152mm min.)
OR76-SLIM	75-1/8" (1908mm)	19-1/8" (486mm)	6" min. (152mm min.)
OR100-SLIM	99-1/2" (2527mm)	19-1/8" (486mm)	6" min. (152mm min.)

Wall Recessed Installation



This product includes a GLASS panel. Always use extreme caution when handling glass. Failure to do so could result in personal injury or property damage.

- Remove power cord and complete hardwiring (see “Hardwiring Installation” section).
- Remove the two screws (one per side) from the inside of the appliance and remove the interior walls. (Fig.2-1). Set the screws/walls aside.

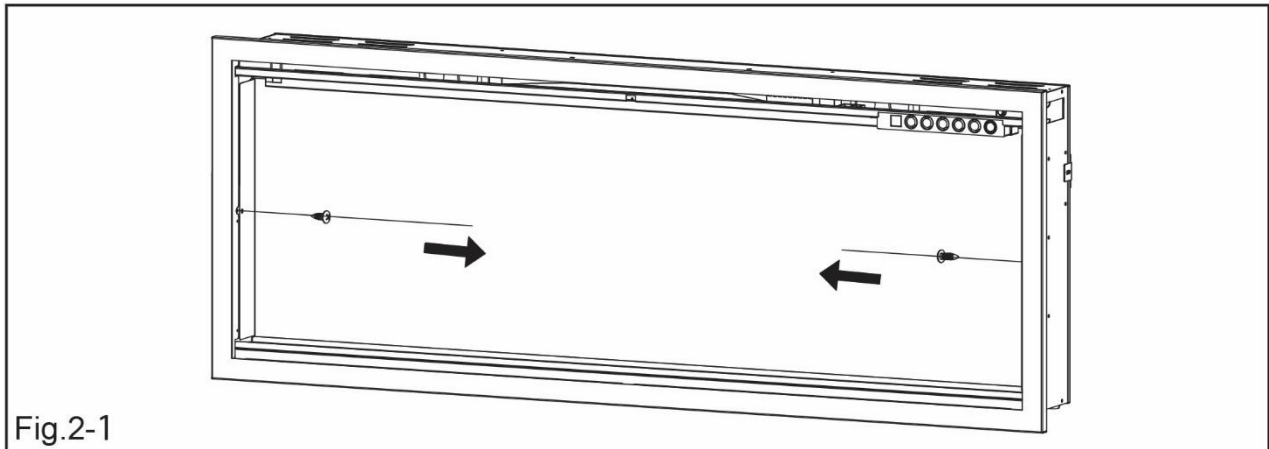

Fig.2-1

- Insert the appliance into the openings (See “Finished Opening Dimensions”) (Fig.2-2) and then secure it by installing 4 screws (supplied) into the slots on the insides (2 per side) (Fig.2-3).
- Next reinstall the two interior walls and two screws previously removed. (Fig.2-4).
- Re-install the front glass. (Fig.2-5)

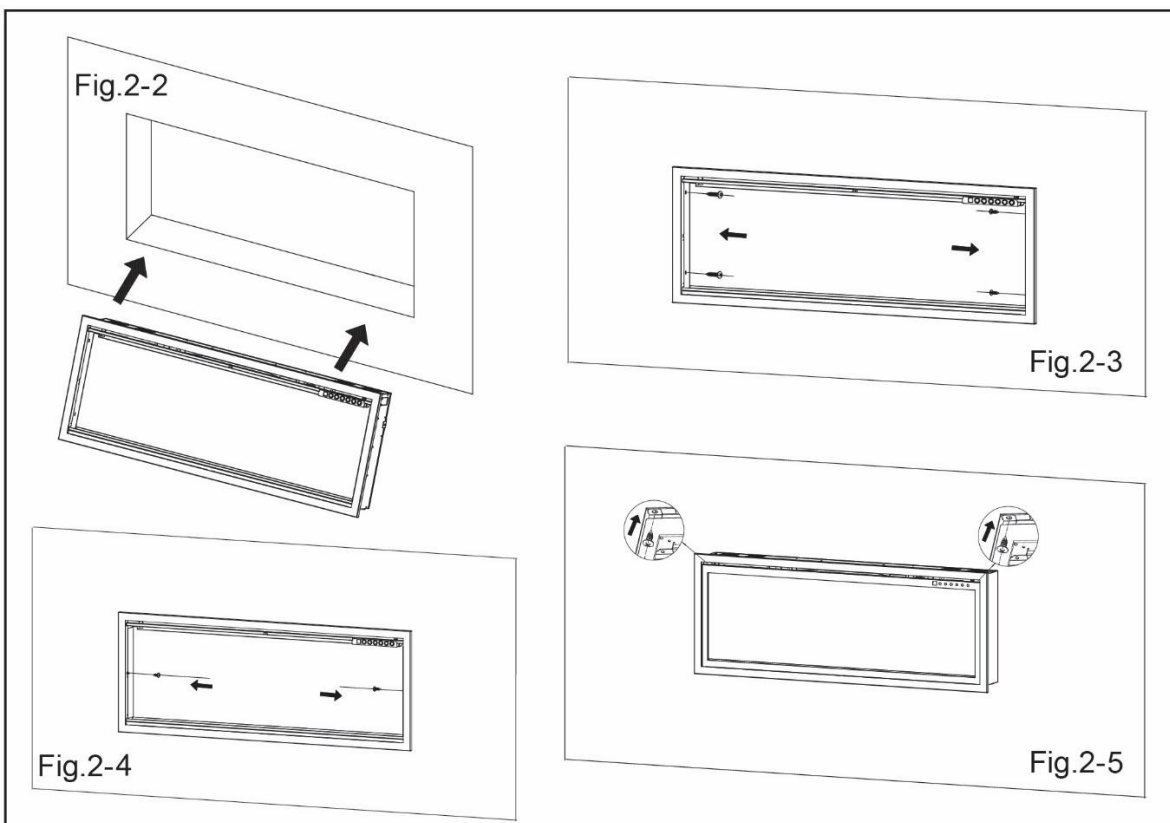

Fig.2-2

Fig.2-3

Fig.2-4

Fig.2-5

Wall Mounted Installation



Due to different materials used on different walls, it is highly recommended for you to consulting with your local builder before you install this electric fireplace.

NOTE: A dedicated 20 Amp (or higher) breaker is required.

- Select a location that is not prone to moisture and is located at least 36" (914mm) away from combustible materials such as curtain drapes, furniture, bedding, paper, etc.
- Have two people hold the appliance against the wall to determine the final location.
- Place the unit face down on a soft, non-abrasive surface.
- Remove the wall bracket (**H**) from the back of the unit by removing the screws, see FIG. 3-1. Set screws aside.
- After you have selected a suitable location for wall mounting, locate the studs on the wall. You must be able to secure to a minimum of 2 studs for proper installation of the bracket.



**FAILURE TO DO SO CAN RESULT IN PERSONAL INJURY
AND/OR DAMAGE TO EQUIPMENT.**

- Using the wall bracket as a guide, mark the mounting hole locations.
- This bracket **MUST** have the hooks facing upward and be level.
- Additional support is provided by using the included wall anchors (**B**) between the studs.
- Additional wall anchors must be installed prior to the wall bracket being mounted.
 - i. To install additional wall anchors, pre-drill (optional) all locations with a 1/8" drill bit.
 - ii. Install the wall anchors with a Philips tip screwdriver.
- Install the wall bracket to the studs using #8 – 1-5/8" (**A**) screws and to the wall anchors with a #8 – 1" screws (**C**).
- With the wall mounting bracket installed, have two people lift the appliance up and insert the two hooks of the wall bracket into the two receiver slots on the back of the appliance.
- Re-insert the two screws that were removed previously.
- Check the appliance for stability ensuring the bracket will not pull free from the wall.
- Install the side skirt panels (**D**) to each side of firebox. FIG 3-2.

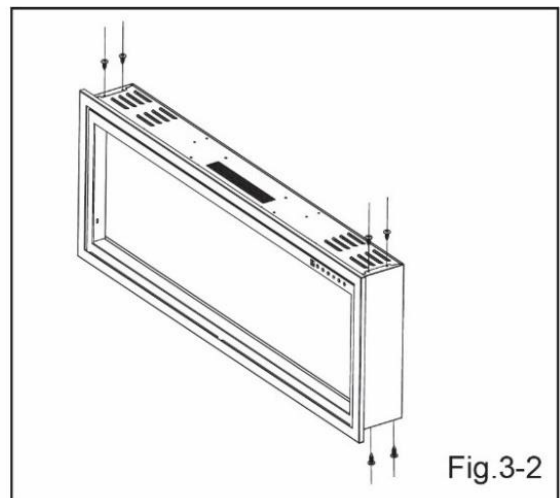
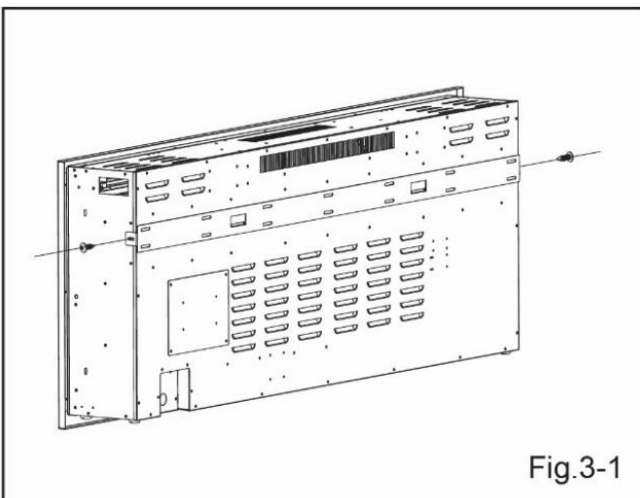

Hardwiring Installation

If it is necessary to hardwire this appliance, a qualified electrician must remove the cord connection and wire the appliance directly to the household wiring.

NOTE: A dedicated 20 Amp (or higher) breaker is required.

The appliance must be electrically connected and grounded in accordance with local codes. In the absence of local codes, use the current CSA C22.1 Canadian Electrical Code in Canada or the current ANSI/NFPA 70 National Electrical Code in the USA.

! TURN OFF POWER FROM CIRCUIT BREAKER FIRST

Note:

There are 3 wires from the appliance junction box: white (neutral), black (power L1), and green (ground) that are connected to 120V power source (circuit breaker panel).

- Remove the 3 securing screws from the junction box cover plate, located on the bottom left-hand, back-side of the appliance (Fig. 4-1).
- Install the strain relief to the junction box cover plate (located in hardware bag) (Fig. 4-2).
- Separate the black, white, and green wires that have the wire nuts on them.
- Remove all the wire nuts. Connect the green wire (**G**) to the supply ground wire, the white wire (**N**) to the supply Neutral wire, and the black wire (**L**) to the supply L1 wire. (Fig. 4-3).
- Resecure the junction box cover plate using the 3 screws previously removed.

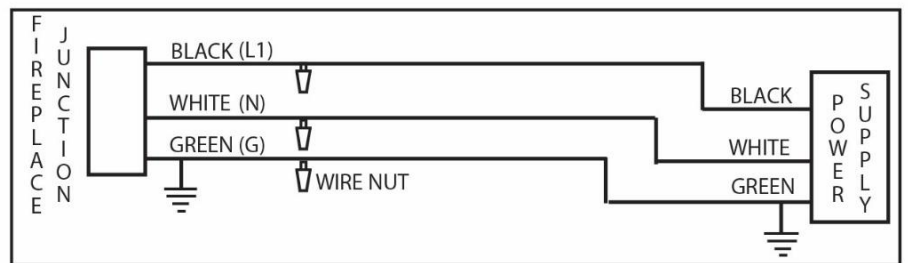
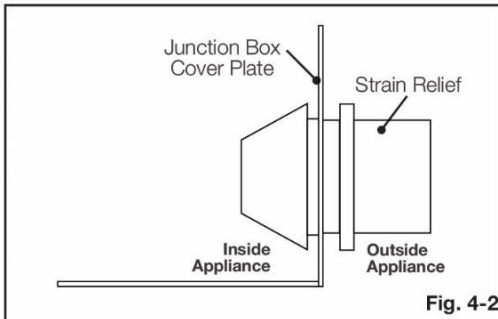
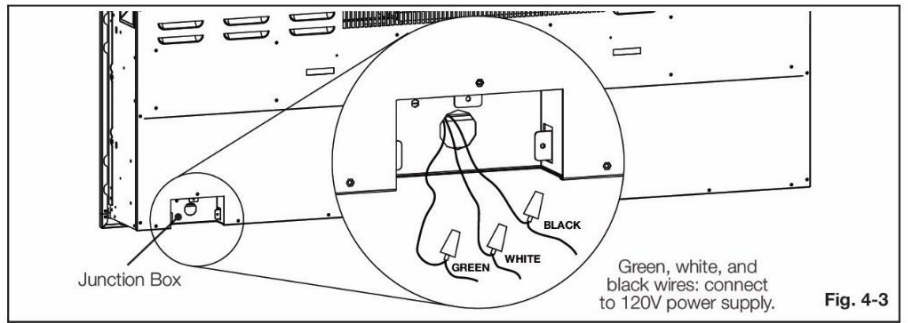
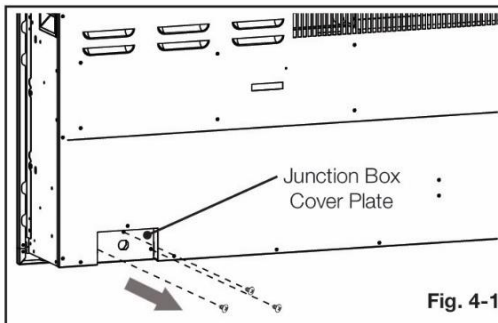

Driftwood Logs and Crushed Glass Installation

- Front glass must be removed and the appliance must be mounted in its final location before the driftwood logs and crushed glass is installed.
- Install driftwood logs first, then add the crushed glass around logs.
- If crushed glass falls into the channel used by the front glass, preventing the front glass from being installed, the channel can be cleared by sliding the crushed glass along the channel until it falls into one of the cleanout slots.
- Photos below shows recommended log placement, but logs may be arranged to customer's liking.

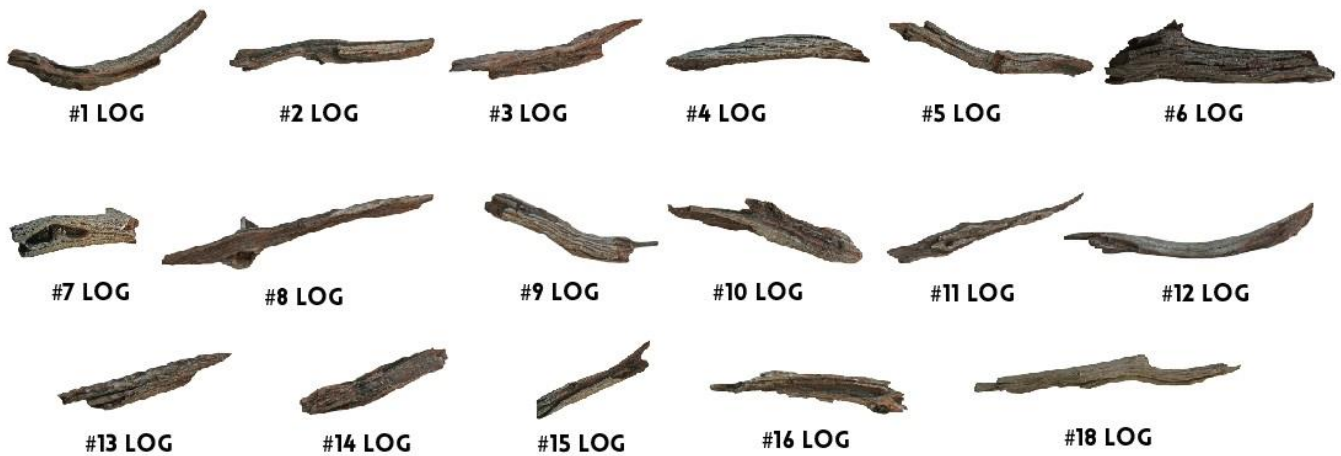

ORION SLIM 52" - LOG PLACEMENT



ORION SLIM 60" - LOG PLACEMENT



ORION SLIM 76" - LOG PLACEMENT



ORION SLIM 100" - LOG PLACEMENT



Operation



Read and understand this entire owner's manual, including all safety information, before plugging in or using this product. Failure to do so could result in electric shock, fire, serious injury, or death.

Power

Plug the power cord into a dedicated 110~120 Volt 20 Amp grounded outlet (see IMPORTANT SAFETY INFORMATION). Make sure the outlet is in good condition and the plug is not loose. NEVER exceed the maximum amperage for the circuit. DO NOT plug other appliances into the same circuit.

Master Power Switch

Located above the Touch Control Panel is the Master Power Switch. Ensure the rocker switch is pressed in the "On" position prior to operating the fireplace.

Note: After resetting the Master Power Switch or from a loss of power, the fireplace takes 20-30 seconds before the fireplace is fully booted and operational.

Pairing the Remote

- With the fireplace ON, press and hold the Power button for 5 seconds until you hear a beep from the fireplace. "P1" will be shown on the display.
- Within 5 seconds of the fireplace beeping, repeatedly press the power button on the remote until the fireplace beeps again.
- Pairing must be completed within 5 seconds or the fireplace pairing will time out of pairing mode.

Operation (Continued)

Methods of Operation

This electric fireplace can be operated by the TOUCH CONTROL PANEL located on the UPPER right corner of the fireplace, by the battery-powered REMOTE CONTROL, or by the MODERN FLAMES APP using a smart phone.

Touch Control Panel



Remote Control

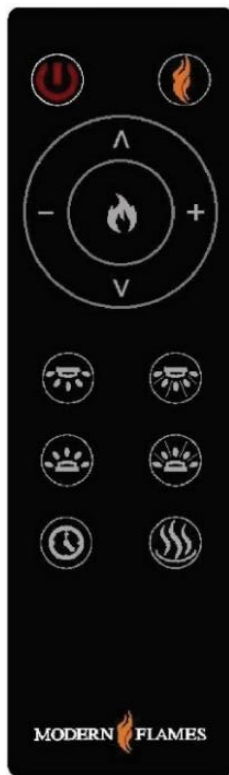



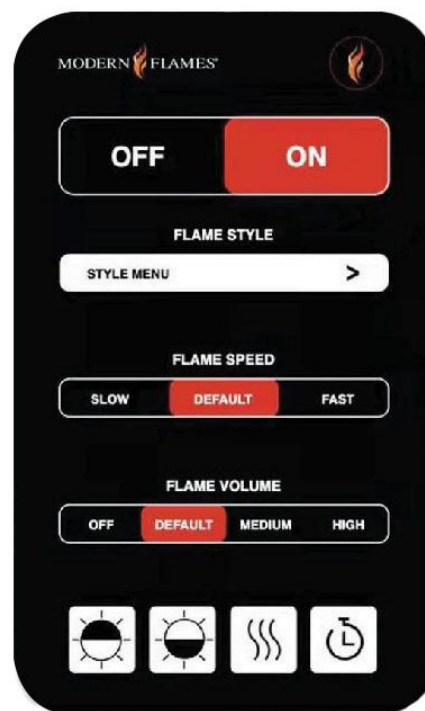



Modern Flames App



Operation – Touch Control Panel



Touch Panel Operation

Button	Function	Action																																							
	<p>ON: Enables control panel functions. Turns on flame.</p> <p>OFF: Disables control panel functions. Turns off flame.</p>	<p>1. Press once: Indicator light turns on. Power turns on. All functions enabled.</p> <p>2. Press again: Flame turns off. Unit goes to standby. All functions turn off.</p> <p>3. NOTE: Press and Hold for 5 seconds: Places fireplace in remote pairing mode. Displays P1 during pairing</p>																																							
	<p>FLAME BUTTON: Changes between flame presets.</p> <p>NOTE: Color effect stays on until power button is turned off. This fireplace has memory function for flame presets.</p>	<p>1. Press once: Flame color illuminates.</p> <p>2. Press again until preset color is reached. In total, three styles of flame with six colors for each flame.</p> <p>NOTE: Press and hold for 5 seconds to start connecting with App.</p>																																							
	<p>DOWNLIGHT BUTTON: Cycles down light colors.</p> <p>NOTE: Downlight color effect stays on until power button is turned off. This fireplace has memory function for down light settings.</p>	<p>1. Press once: Cycle Down light.</p> <p>2. Press again until desired color is reached. In total ten colors and one fade mode.01-02-03-04-05-06-07-08-09-10-11-00 (off)</p> <p>NOTE: Press and hold for 5 seconds to turn on/off night light mode.</p>																																							
	<p>MEDIA BED BUTTON: Cycles media bed colors.</p> <p>NOTE: Media bed color effect stays on until power button is turned off. This fireplace has memory function for media bed settings.</p>	<p>1. Press once: Turns on ember bed.</p> <p>2. Press again until desired color is reached. In total ten colors and one fade mode.01-02-03-04-05-06-07-08-09-10-11-00 (off).</p>																																							
	<p>HEATER BUTTON: Turns heater on and off.</p> <p>NOTE: The heater only works when the flame is on. If the flame is off, the heater will not turn on.</p> <p>NOTE: To prevent overheating, the heater fan will blow cool air for 8-10 seconds after the heater turns off.</p>	<p>1. Press once: Turns the heater and blower on.</p> <p>2. Press again until it cycles thru the heater settings. Settings: H0 - Heater and blower off F – Fan only H1 - Low Heater H2 - High Heater</p> <p>NOTE: Press and hold the heater button for 5 seconds to lock/unlock the heater and thermostat. H0 will be displayed when locked.</p>																																							
	<p>THERMOSTAT BUTTON: Turns heater on / off to maintain room at selected temperature.</p> <p>NOTE: Press the button for 5 seconds to switch between °C and °F.</p>	<p>1. Press once: Touch-on control panel indicator becomes active.</p> <p>2. Press again until desired temperature is reached. Digital display shows settings 0-10. Table shows corresponding temperatures.</p> <table border="1"> <thead> <tr> <th>NO</th> <th>0</th> <th>1</th> <th>2</th> <th>3</th> <th>4</th> <th>5</th> <th>6</th> <th>7</th> <th>8</th> <th>9</th> <th>10</th> <th>NO</th> </tr> </thead> <tbody> <tr> <td>°C</td> <td>20</td> <td>21</td> <td>22</td> <td>23</td> <td>24</td> <td>25</td> <td>26</td> <td>27</td> <td>28</td> <td>29</td> <td>30</td> <td>°C</td> </tr> <tr> <td>°F</td> <td>68</td> <td>70</td> <td>72</td> <td>74</td> <td>76</td> <td>78</td> <td>80</td> <td>82</td> <td>84</td> <td>86</td> <td>88</td> <td>°F</td> </tr> </tbody> </table>	NO	0	1	2	3	4	5	6	7	8	9	10	NO	°C	20	21	22	23	24	25	26	27	28	29	30	°C	°F	68	70	72	74	76	78	80	82	84	86	88	°F
NO	0	1	2	3	4	5	6	7	8	9	10	NO																													
°C	20	21	22	23	24	25	26	27	28	29	30	°C																													
°F	68	70	72	74	76	78	80	82	84	86	88	°F																													



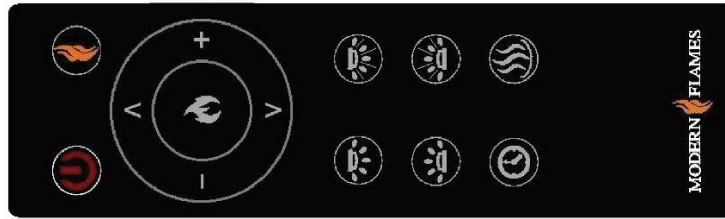

Operation – Remote Control



Remote Control Operation

Button	Function	Action
	ON: Enables control panel functions. Turns on flame. OFF: Disables control panel functions. Turns off flame.	1. Press once: Indicator light turns on. Power turns on. All functions enabled. 2. Press again: Flame turns off. Unit goes to standby. All functions turn off.
	HOME BUTTON: Returns the fireplace to the default color settings.	1. Press once: Flame video changes to flame style 1, color yellow. Ember bed and down light changes to orange. Flame speed changes to default and sound level changes to low.
	FLAME BUTTON: Cycles between flame styles. ▲: Cycles up between preset of current flame styles. ▼: Cycles down between preset of current flame styles. + : Increases flame speed of current flame style and color. --: Decrease flame speed of current flame style and color. NOTE: This fireplace has memory function for flame.	1. Press flame button once: Flame switches to next flame style in the sequence. 2. Press flame button again until desired style is reached. In total, three flame styles. Note: Press and hold for 5 seconds enables Wi-Fi pairing mode 3. Press ▲ once: Changes up to the next preset of current flame style. 4. Press ▲ again until desired preset is selected from 1C-2C-3C-4C-5C-6C . 5. Press ▼ once: Changes down to the next preset of current flame style. 6. Press ▼ again until desired preset is selected from 6C-5C-4C-3C-2C-1C . 7. Press + button to increase the flame speed. Displayed: 01-02-03 . 8. Press -- button to decrease the flame speed. Displayed: 03-02-01 .
	AUDIO BUTTON: Raises and lowers the audio from the fireplace.	1. Press once: Changes the volume level. 2. Press again cycles between volume settings. Volume settings: S0 - Off S1 - Low S2 - Medium S3 - High
	DOWNLIGHT BUTTON: Cycles down light colors. NOTE: Downlight color effect stays on until power button is turned off. This fireplace has memory function for down light settings.	1. Press once: Cycle downlight. 2. Press again until desired color is reached. In total ten colors and one fade mode. 01-02-03-04-05-06-07-08-09-10-11 NOTE: Press and hold for 5 seconds to turn on/off night light mode.
	DOWNLIGHT BRIGHTNESS BUTTON: Makes downlight dimmer and brighter. NOTE: LED down light brightness stays on until power button is turned off.	1. Press once: Brightness becomes active. 2. Press again until desired setting is reached. In total 5 levels. From L4 - L3 - L2 - L1 - L0 (off)

Operation – Remote Control (Continued)

Button	Function	Action
	<p>MEDIA BED BUTTON: Cycles media bed colors.</p> <p>NOTE: Media bed color effect stays on until power button is turned off. This fireplace has memory function for media bed settings.</p>	<p>1. Press once: Turns on ember bed.</p> <p>2. Press again until desired color is reached. In total ten colors and one fade mode.01-02-03-04-05-06-07-08-09-10-11</p>
	<p>MEDIA BRIGHTNESS BUTTON: Makes media bed dimmer and brighter.</p> <p>NOTE: LED media light brightness stays on until power button is turned off.</p>	<p>1. Press once: Brightness becomes active.</p> <p>2. Press again until desired setting is reached. In total 5 levels. From E4 - E3 - E2 - E1 - E0 (off)</p>
	<p>TIMER BUTTON: Controls timer settings to turn off fireplace at selected time. Settings range from 30 min to 8 hours.</p>	<p>1. Press once: Indicator light turns on. Timer defaults to 0.5 hours.</p> <p>2. Press again until desired setting is reached. 00(off)-30-1H-2H-3H-4H-5H-6H-7H-8H</p>
	<p>HEATER BUTTON: Turns heater on and off.</p> <p>NOTE: The heater only works when the flame is on. If the flame is off, the heater will not turn on.</p> <p>NOTE: To prevent overheating, the heater fan will blow cool air for 8-10 seconds after the heater turns off.</p>	<p>1. Press once: Turns the heater and blower on.</p> <p>2. Pressing Additionally: Cycles thru heater settings. Settings: H0 - Heater and blower off F – Fan only H1 - Low Heater H2 - High Heater</p> <p>NOTE: Press and hold the heater button for 5 seconds to lock/unlock the heater and thermostat. H0 will be displayed when locked.</p>

Download Smart Phone App

Smart Phone App Connection

Note: Download the Modern Flames App from your App store before connecting



MODERN  FLAMES
Download Mobile App



Wi-Fi – Initial Log-in

- Search for and install the “Modern Flames” app from the Google Play or Apple App store or scan the QR code on the previous page.

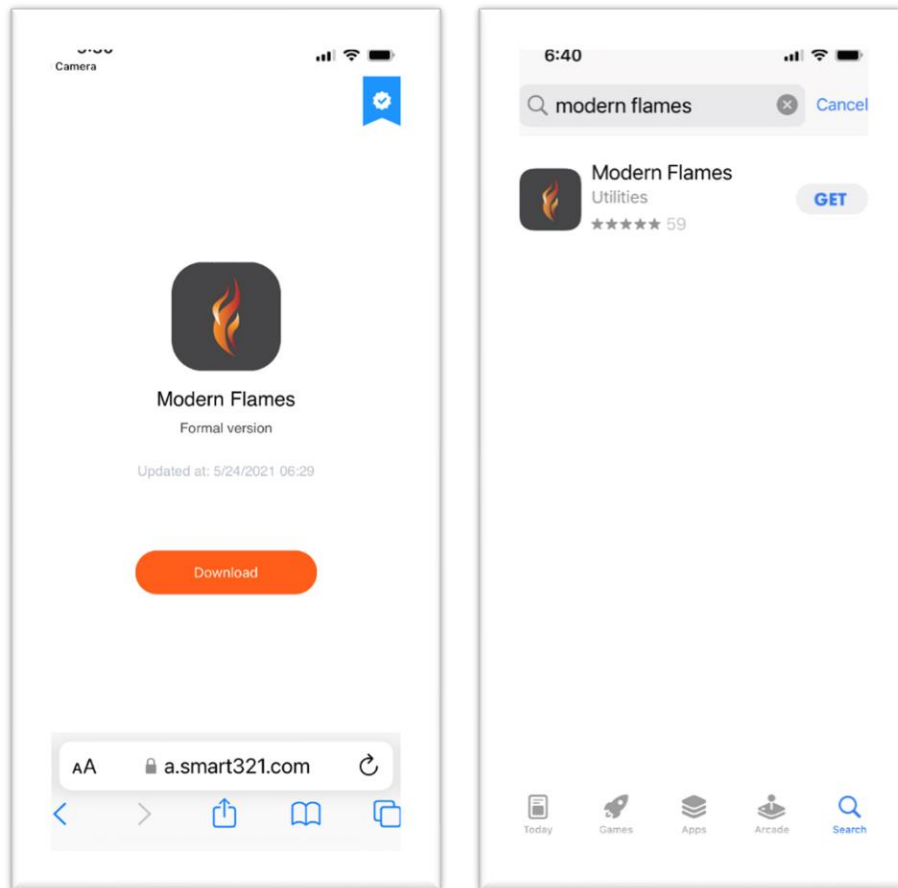

- After the App is installed, log in to the Modern Flames App. Must have Wi-Fi and Bluetooth enabled on your smart phone.
- Once opened from the home page, select the add “+” symbol.

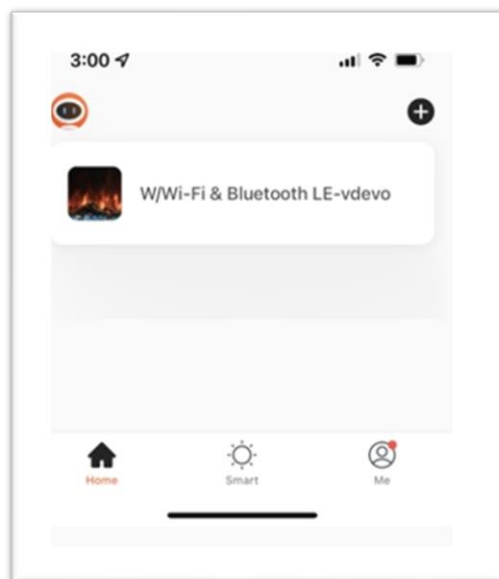

Wi-Fi – Pairing

Add Manually

- Select the series of fireplace that will be paired with and follow the instructions.

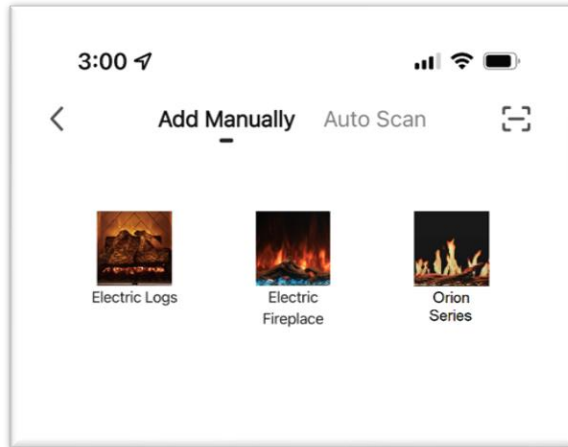

- When pairing via Wi-Fi, the 2.4 GHz Wi-Fi signal must be used. Ensure the appropriate login information is entered before continuing to the next step.

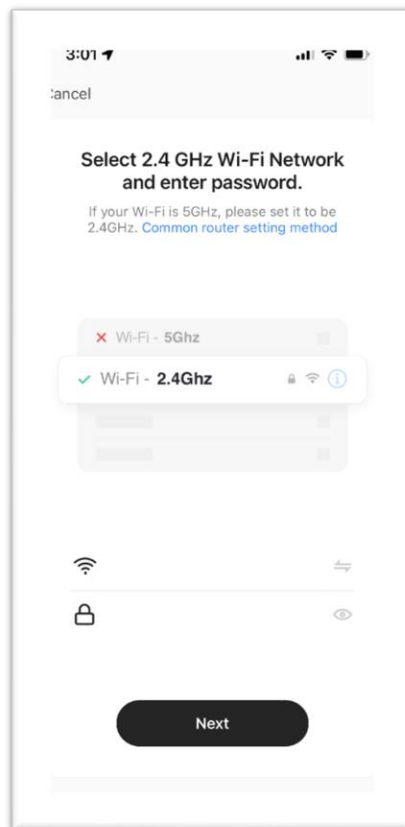

Wi-Fi – Pairing (Continued)

- Ensure the fireplace is ON.
- Hold the “Flame” button on the manual touch controls for 5 seconds.
 - i. In EZ Mode, the fireplace will display “P0”.
 - ii. In AP Mode, the fireplace will display “P2”
 - iii. Holding the flame button for an additional 5 seconds will cycle the fireplace between EZ Mode and AP Mode.

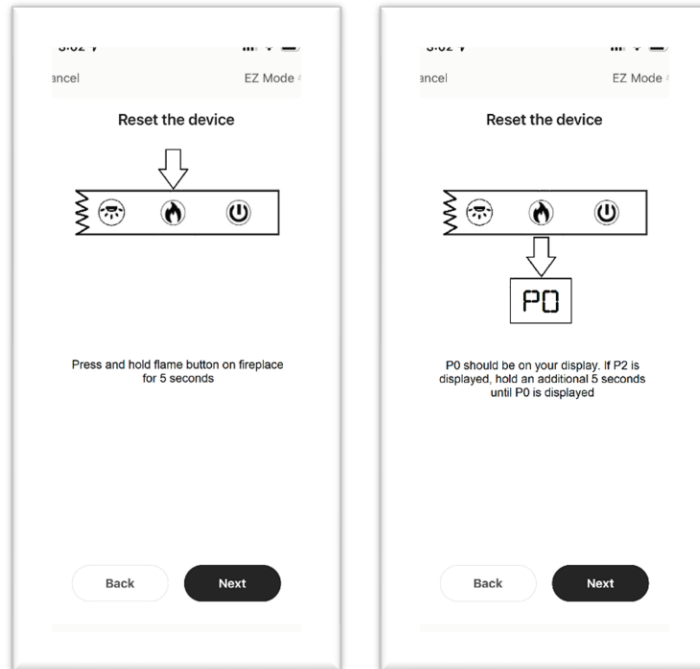

- Device and APP should now begin to pair. Depending on Wi-Fi, this can take up to two minutes to pair and may need to be repeated more than once.

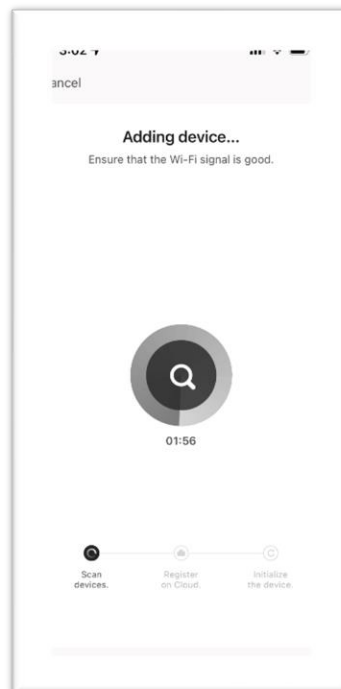

Wi-Fi – Pairing (Continued)

- The fireplace display will show “P4” and the downlight LEDs will blink green on a successful pair.
 - i. NOTE: Do not turn OFF or disconnect the fireplace from power while pairing the Wi-Fi or performing updates. Failure to do so can result in damage to electrical components of the fireplace. Damage as a result of this may not be covered under warranty. Questions or assistance in pairing device, contact Modern Flames at customerservice@modernflames.com or call (877) 246-9653 Monday-Friday, 8:00 am – 5:00 pm (MST).

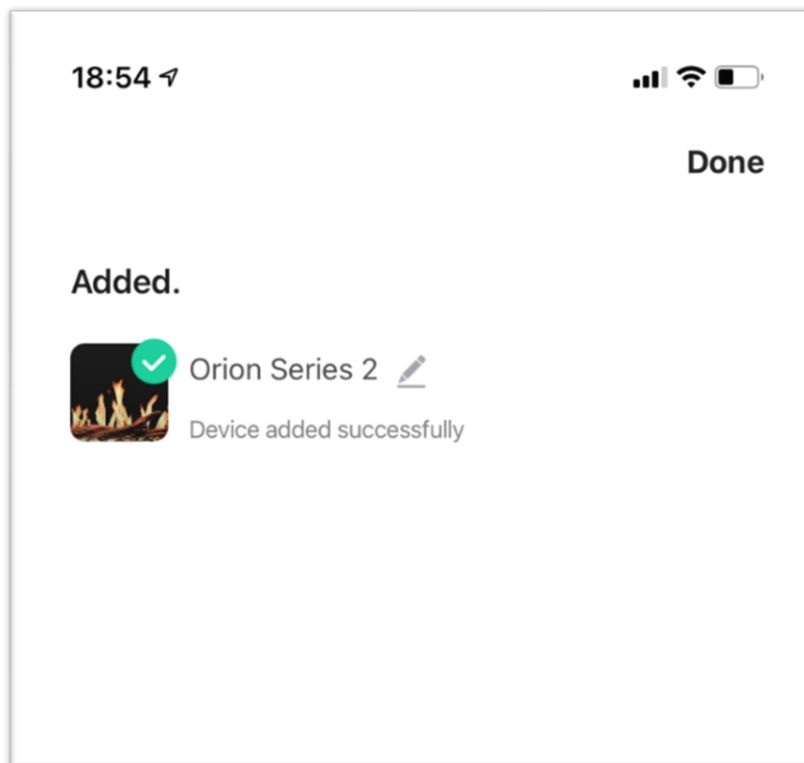

Wi-Fi – Pairing (Continued)

Auto Scan

- Select auto scan from the top of the App.

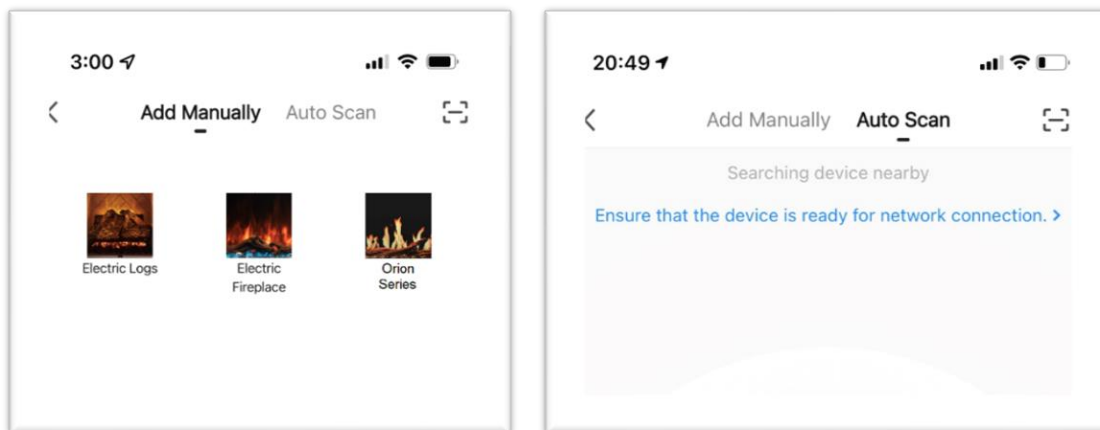

- On the fireplace touch controls, press and hold the “Flame” button for 5 seconds. The fireplace will show either “P0” or “P2”. This will place the fireplace in pairing mode.

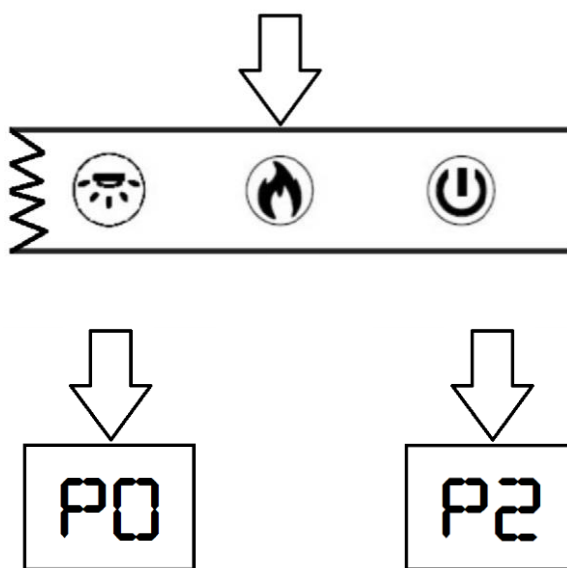

Wi-Fi – Pairing (Continued)

- Auto scan will search for available devices. Upon selecting the available fireplace, select the “Next” button if the app does not proceed automatically. If the scan fails to find a fireplace, press and hold the “Flame” button on the manual touch controls to switch pairing modes.

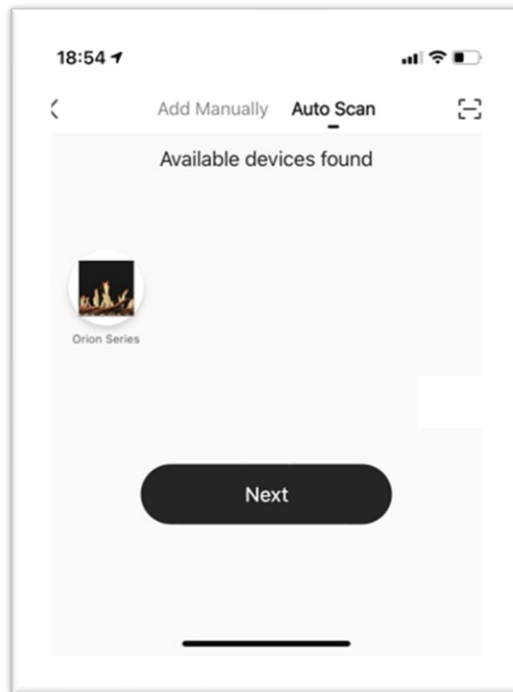

- Enter in the Wi-Fi information. The information must be entered to be able to proceed to the next step.
- The App will begin connecting.

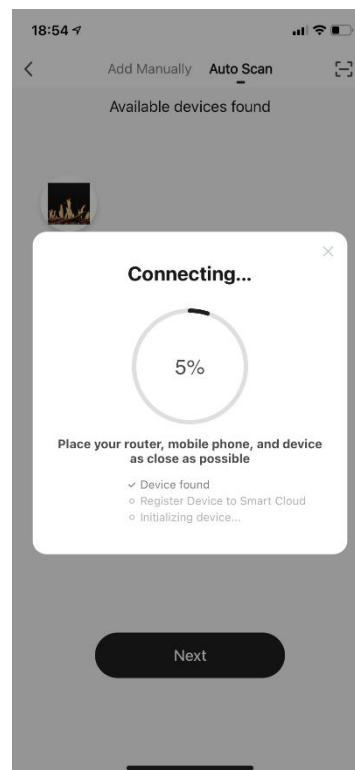
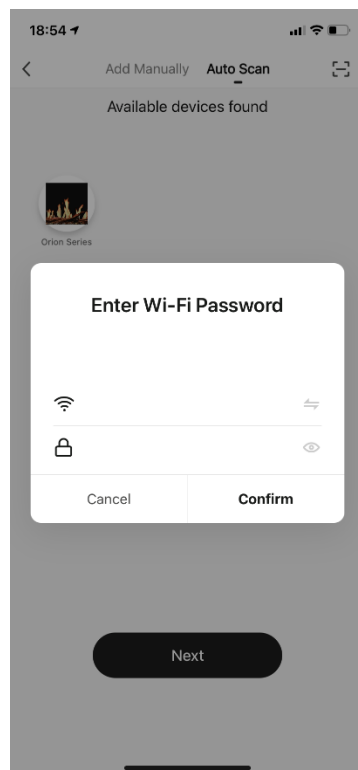

Wi-Fi – Pairing (Continued)

- The fireplace display will show “P4” and the downlight LEDs will blink green on a successful pair.
 - i. NOTE: Do not turn OFF or disconnect the fireplace from power while pairing the Wi-Fi or performing updates. Failure to do so can result in damage to electrical components of the fireplace. Damage as a result of this may not be covered under warranty. Questions or assistance in pairing device, contact Modern Flames at customerservice@modernflames.com or call (877) 246-9653 Monday-Friday, 8:00 am – 5:00 pm (MST).

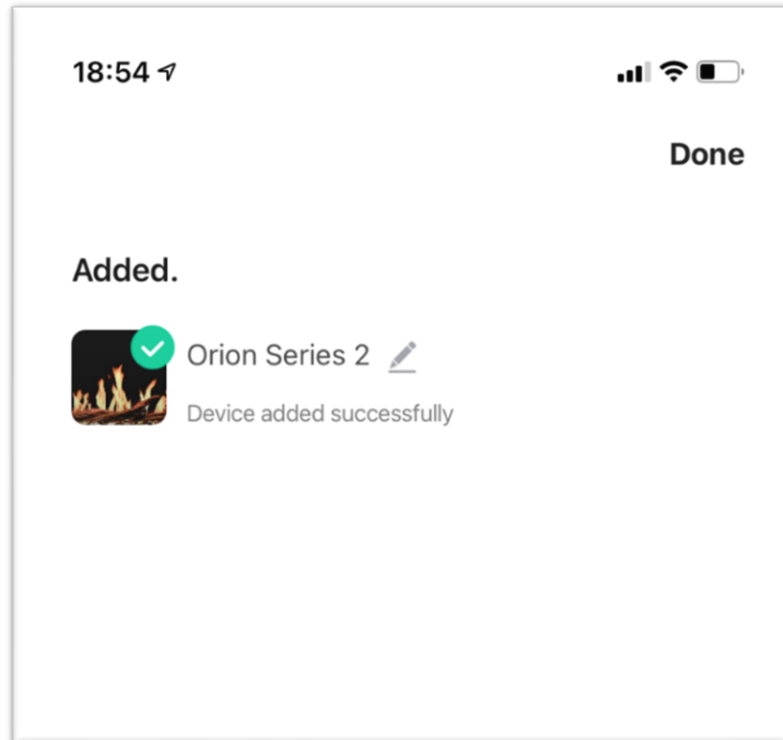

Operation – Smart Phone App

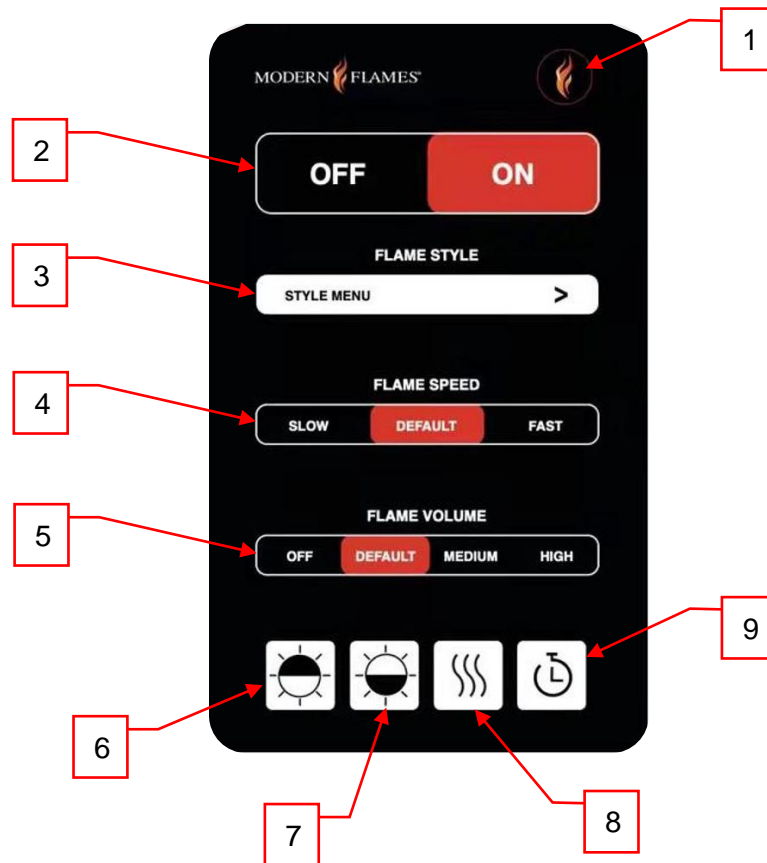

Home Screen

Button	Function	Action
1	Home Button: Returns the fireplace to the default color settings.	1. Press once: Flame video changes to flame style 1, color yellow. Ember bed and down light changes to orange. Flame speed changes to default and sound level changes to low.
2	Power Off/On Slider: Turns the fireplace off and on.	1. Slide to the Off position: Turns the fireplace OFF. 2. Slide to the On position: Turns the fireplace ON.
3	Flame Style: Opens flame style sub-menu for selecting flame style and color. 3 styles with 6 colors for each of the styles.	1. Press once: Opens the flame style sub-menu page to select a new flame style.
4	Flame Speed Slider: Changes the flame speed of currently displayed flame. Cycles between SLOW , DEFAULT , and FAST .	1. Slide to the Slow position: Flame moves at the slowest speed. Fireplace displays: 01 2. Slide to the Default position: Flame moves at the default speed. Fireplace displays: 02 3. Slide to the Fast position: Flame moves at the fastest speed. Fireplace displays: 03
5	Flame Volume Slider: Changes the sound effect volume of the fireplace between 4 different volumes. Can cycle between OFF , DEFAULT , MEDIUM , High .	1. Slide to the Off position: Sound effects are turned off. Fireplace displays: S0 2. Slide to the default position: Sound effects are at the lowest/default sound level. Fireplace displays: S1 3. Slide to the Medium position: Sound effects are at the middle sound level. Fireplace displays: S2 4. Slide to the High position: Sound effects are at the highest sound level. Fireplace displays: S3

Operation – Smart Phone App (Continued)

Home Screen (Continued)

Button	Function	Action
6	Downlight Button: Opens the downlight sub-menu.	1. Press once: Opens the downlight sub-menu page to select new colors for downlighting.
7	Ember Bed Button: Opens the ember bed sub-menu.	1. Press once: Opens the ember bed sub-menu page to select new colors for the ember bed.
8	Heater Button: Opens the heater sub-menu.	1. Press once: Opens a new page to make changes to the heater settings.
9	Timer Button: Opens the timer sub-menu.	1. Press once: Opens the timer sub-menu for various timer related functions.



Flame Style Options

Button	Function	Action
3.1	Return Button: Returns to the previous page.	1. Press once: Returns to the previous page.
3.2	Style One Button: Opens the flame style one sub-menu.	1. Press once: Opens the flame style one sub-menu.
3.3	Style Two Button: Opens the flame style two sub-menu.	1. Press once: Opens the flame style two sub-menu.
3.4	Style Three Button: Opens the flame style three sub-menu.	1. Press once: Opens the flame style two sub-menu.

Operation – Smart Phone App (Continued)

- 3.2 menu depicted. Functions and actions are the same for the 3.3 and 3.4 menu.



Flame Style One/Two/Three Color Menu

Note: Flame Style One (3.2), Two (3.3), and Three (3.4) all function the same as below

Button	Function	Action
3.2.1	Return Button: Returns to the previous page.	1. Press once: Returns to the previous page.
3.2.2	Yellow Flame Button: Changes the fireplace to the Yellow flame.	1. Press once: Changes the fireplace to the Yellow flame. Ember bed and downlighting change to the designated preset.
3.2.3	Orange Flame Button: Changes the fireplace to the Orange flame.	1. Press once: Changes the fireplace to the Orange flame. Ember bed and downlighting change to the designated preset.
3.2.4	Blue Flame Button: Changes the fireplace to the Blue flame.	1. Press once: Changes the fireplace to the Blue flame. Ember bed and downlighting change to the designated preset.
3.2.5	Green Flame Button: Changes the fireplace to the Green flame.	1. Press once: Changes the fireplace to the Green flame. Ember bed and downlighting change to the designated preset.
3.2.6	Purple Flame Button: Changes the fireplace to the Purple flame.	1. Press once: Changes the fireplace to the Purple flame. Ember bed and downlighting change to the designated preset.
3.2.7	White Flame Button: Changes the fireplace to the White flame.	1. Press once: Changes the fireplace to the White flame. Ember bed and downlighting change to the designated preset.

Operation – Smart Phone App (Continued)

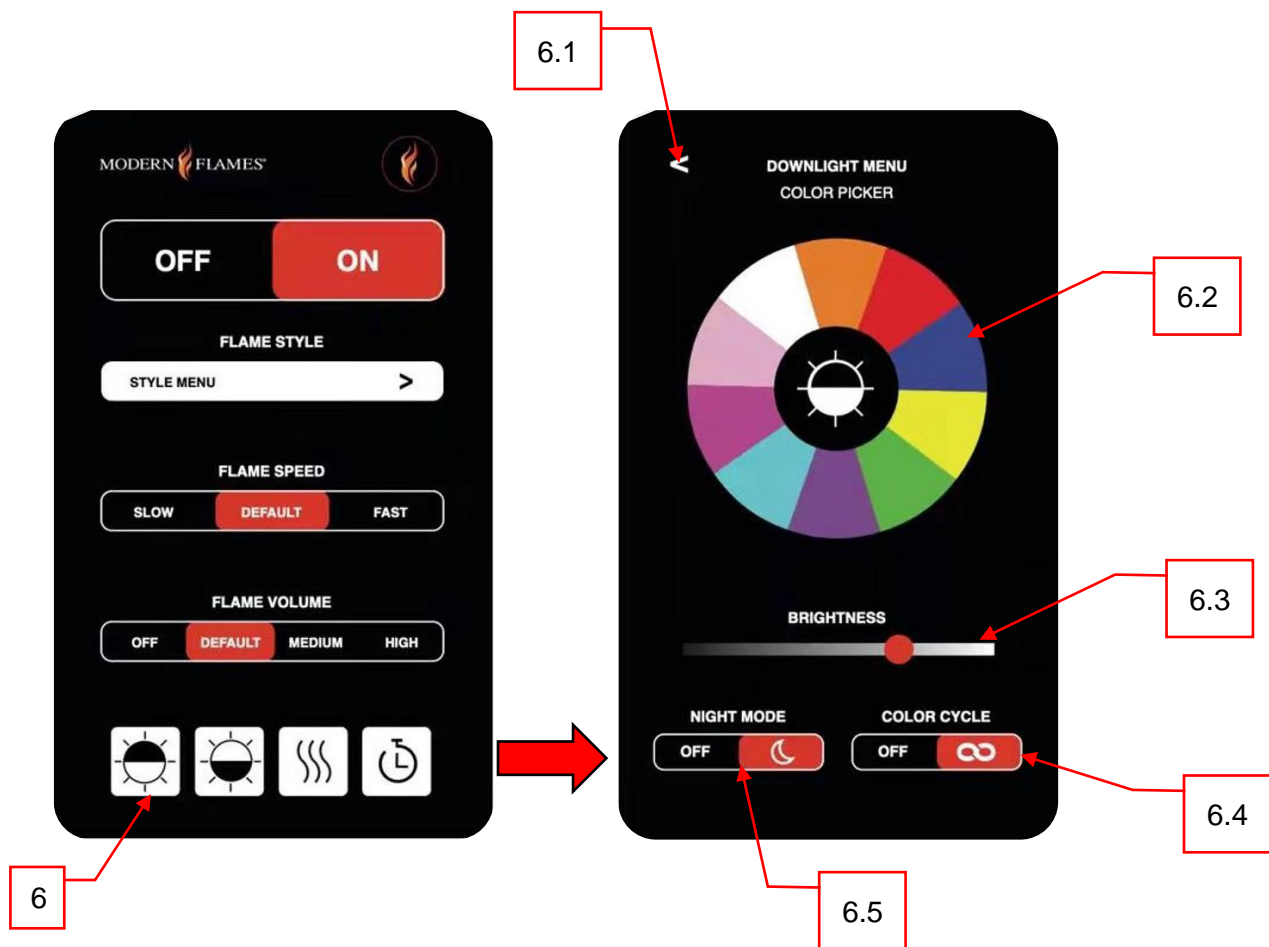

Downlight Menu		
Button	Function	Action
6.1	Return Button: Returns to the previous page.	1. Press once: Returns to the previous page.
6.2	Color Wheel Button: Changes the color of the downlight to the selected color.	1. Press once: Selecting a color, the downlight will change to the selected color.
6.3	Brightness Slider: Changes the brightness of the downlighting.	1. Sliding to the left/dark: Dims the brightness of the downlight. 2. Sliding to the right/light: Brightens the downlight.
6.4	Color Cycle Slider: Cycles the downlight colors between all colors shown on the color wheel.	1. Slide to OFF position: Downlight stays a solid color. 2. Slide to ON (Infinity) position: Downlight cycles between the 10 colors shown on the color wheel.
6.5	Night Mode Slider: Enables night light mode.	1. Slide to OFF position: Downlight is on and fireplace functions like normal. 2. Slide to ON (Moon) position: Downlight is on and all other functions of the fireplace are off.

Operation – Smart Phone App (Continued)

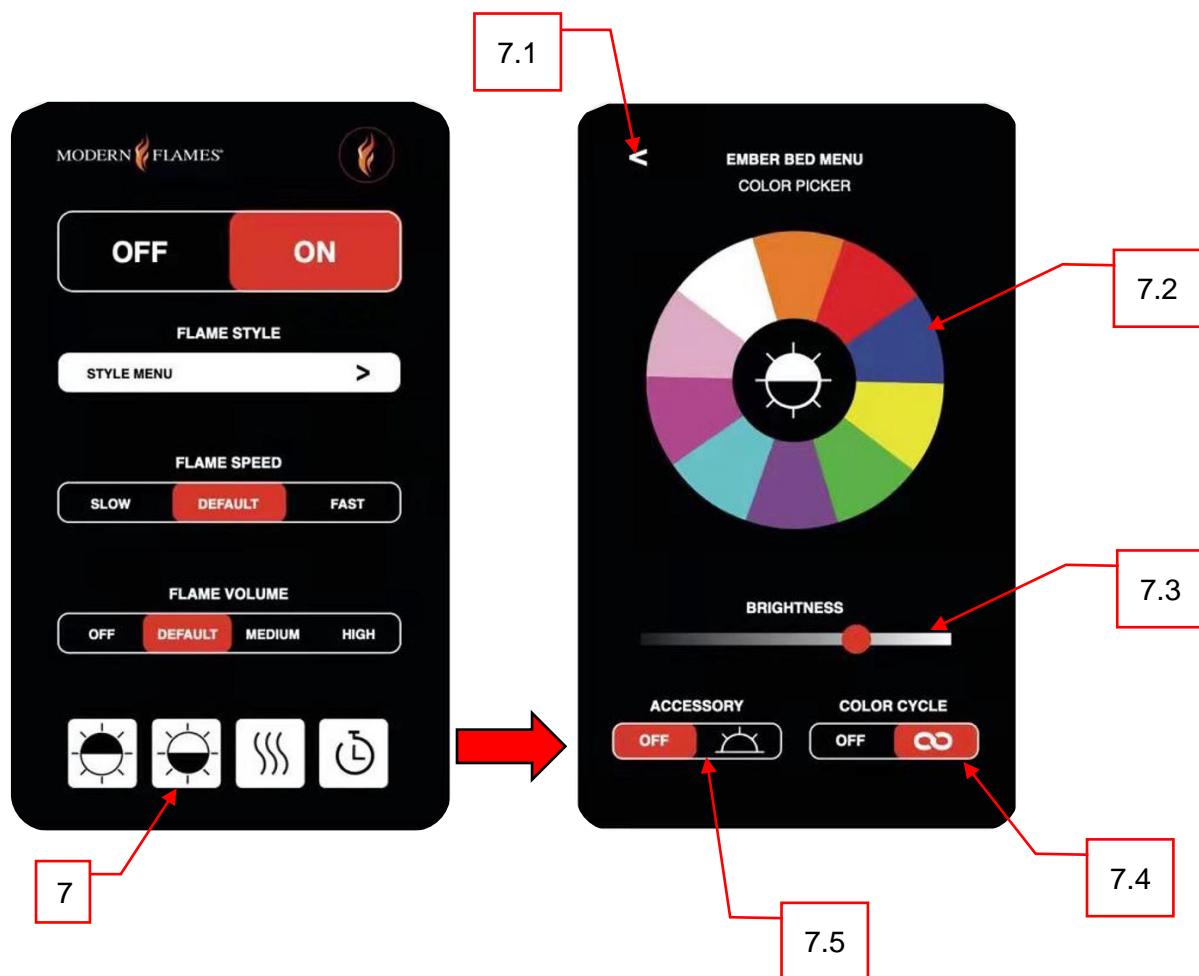

Ember Bed Menu		
Button	Function	Action
7.1	Return Button: Returns to the previous page.	1. Press once: Returns to the previous page.
7.2	Color Wheel Button: Changes the color of the ember bed to the selected color.	1. Press once: Selecting a color, the ember bed will change to the selected color.
7.3	Brightness Slider: Changes the brightness of the ember bed.	1. Sliding to the left/dark: Dims the brightness of the ember bed. 2. Sliding to the right/light: Brightens the ember bed.
7.4	Color Cycle Slider: Cycles the ember bed colors between all colors shown on the color wheel.	1. Slide to OFF position: Ember bed stays a solid color. 2. Slide to ON (Infinity) position: Ember bed cycles between all colors shown on the color wheel.
7.5	Accessory Mode Slider: Enables ember bed accessory. Note: Not applicable to all models.	1. Slide to OFF position: Ember bed accessory is off. 2. Slide to ON (Sun) position: Ember bed accessory is on.

Operation – Smart Phone App (Continued)

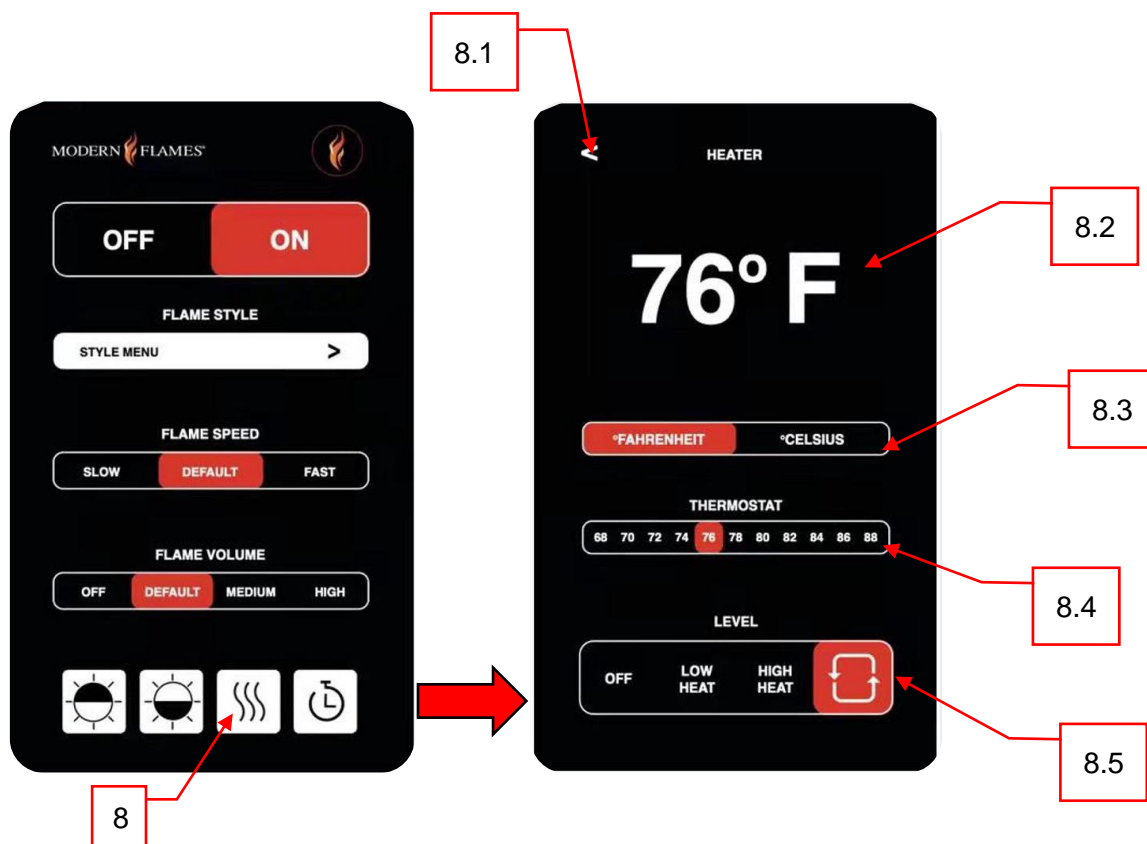

Heater Menu		
Button	Function	Action
8.1	Return Button: Returns to the previous page.	1. Press once: Returns to the previous page.
8.2	Ambient Temperature: The fireplace ambient air temperature reading.	1. Press once: No action.
8.3	Temperature Scale Slider: Changes between Fahrenheit and Celsius.	1. Sliding to Fahrenheit: Changes the scale of the ambient temperature, thermostat selector, and the fireplace to Fahrenheit. 2. Sliding to Celsius: Changes the scale of the ambient temperature, thermostat selector, and the fireplace to Celsius.
8.4	Thermostat Temperature Slider: Changes the thermostat value of the fireplace, enabling or disabling the heater at the set temperature.	1. Slide to preset position: Changes the thermostat to the selected number. Heater will turn on until the ambient temperature reaches the selected thermostat value. Heater will turn off once the ambient temperature is equal to or greater than the thermostat value.
8.5	Heat Output Slider: Changes whether the heater is off, low heat, high heat, or recirculation (fan only).	1. Slide to OFF position: The heater is off. 2. Slide to Low Heat position: The heater will run at low power. 3. Slide to High Heat position: The heater will run at high power. 4. Slide to Recirculation position: Fan is blowing to recirculate the air. Heater is off.

Operation – Smart Phone App (Continued)

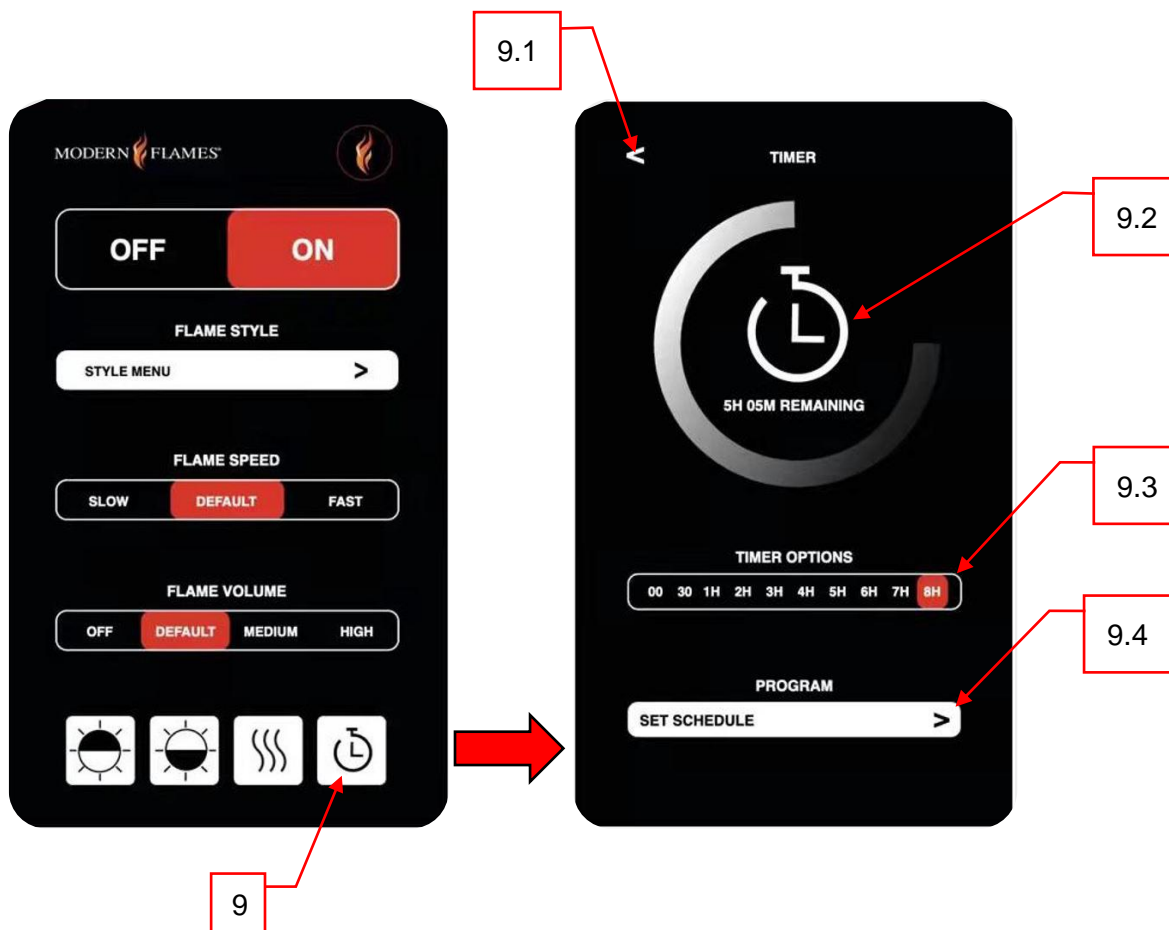

Timer Menu		
Button	Function	Action
9.1	Return Button: Returns to the previous page.	1. Press once: Returns to the previous page.
9.2	Countdown Timer: Displays remaining time left on the selected time. Shows OFF when not in use. NOTE: Fireplace will turn off once the timer reaches zero.	1. Press once: No action.
9.3	Preset Timer Options: Changes the amount of time for the fireplace to run before turning off.	1. Slide to preset position: Changes the timer to the selected number. The fireplace will turn off once the timer reaches zero. 2. Sliding to 00 position: Turns the timer off. The fireplace will stay on until the user manually turns off the fireplace.
9.4	Weekly Program Schedule: Opens the Weekly Program Schedule sub-menu.	1. Press once: Opens the Weekly Program Schedule sub-menu.

Operation – Smart Phone App (Continued)



Weekly Program Schedule Menu

Button	Function	Action
9.4.1	Return Button: Returns to the previous page.	1. Press once: Returns to the previous page.
9.4.2	Programming Days: Displays if a day has a program assigned to it. Selecting a day will open that day's sub-menu.	1. Press on a day once: Opens that day's sub-menu.
9.4.3	Color Key: Shows the meaning of the different color codes used in the daily programming.	1. Press once: No action.
9.4.4	Reset Button: Clears the programming from ALL days.	1. Press once: Clears the programming from ALL days. All days revert to default state.

Operation – Smart Phone App (Continued)



Daily Program Schedule Menu		
Button	Function	Action
9.4.2.1	Return Button: Returns to the previous page.	1. Press once: Returns to the previous page.
9.4.2.2	Individual Day Programming: Shows the programming for the selected day. Allows for programming of the selected day.	1. Highlight desired time frame: Applies desired function to highlighted area. Note: Must first select desired function from Color Key (9.4.2.3). Note: Heater On and Recirculate can not be scheduled at the same time. Note: Off clears the selected programming. Note: The app prevents from scheduling conflicting modes. Note: Manual settings supersede programmed settings.
9.4.2.3	Color Key: Shows the meaning of the different color codes used in the daily programming.	1. Press Off once: Allows to schedule the fireplace to turn off. 2. Press Heater On once: Allows to schedule the fireplace to turn the heater on until the ambient air reaches or exceeds the thermostat temperature. 3. Press Flames On once: Allows to schedule the flames to turn on. 4. Press Recirculate once: Allows to schedule the recirculating air.
9.4.2.4	Reset Button: Clears the programming from the whole day.	1. Press once: Clears the programming from the whole day. The day revert to default state.

Operation – Important Warnings

Note:

When the heater is first turned on, a slight odor may be present. This is normal and should not occur again unless the heater is not used for a long period of time.

To improve operation, aim the remote control at the front of the fireplace. Quickly pressing buttons on the remote without allowing the fireplace to complete the previous operation may result in operational errors. Allow the fireplace to complete each command before issuing another.

Remote Control Battery Information

- Remote control uses one CR2032 battery (Included)



Never dispose of batteries in fire. Failure to observe this precaution may result in an explosion. Dispose of batteries at your local hazardous material processing center.

Temperature Limiting Control

This heater is equipped with a Temperature Limiting Control. Should the heater reach an unsafe temperature, the heater will automatically turn Off.

To Reset:

- Remove power from the fireplace. Wait 5 minutes.
 - Unplug the fireplace or turn off the appropriate breaker at the circuit breaker box.
- Inspect the fireplace to ensure no vents are blocked or clogged with dust or lint. Using a vacuum can help clear the areas if needed.
- Apply power to the fireplace.
- If problem continues, have the wiring and outlet inspected by a professional.

Care – Cleaning



Always turn heater OFF and unplug power cord from the outlet before cleaning, performing maintenance, or moving this fireplace. Failure to do so could result in electric shock, fire, or personal injury.

Never immerse in water or spray with water. Doing so could result in electric shock, fire, or personal injury.

Metal:

- Clean using a soft cloth, slightly dampened with soapy water.
- DO NOT use a brass polish or household cleaners as these products will damage the metal trim.

Glass:

- Use an ammonia-free glass cleaner sprayed onto a cloth or towel. Dry thoroughly with a paper towel or lint-free cloth.
- DO NOT use abrasive cleansers, liquid sprays, or any cleaner that could scratch the surface.

Vents:

- Use a vacuum or duster to remove dust and dirt from the heater and vent areas.

Plastic:

- Wipe gently with a slightly damp cloth and a mild solution of dish soap and warm water.
- DO NOT use abrasive cleaners, liquid sprays, or any cleaner that could scratch the surface.

Care – Maintenance



Risk of electric shock! Do not open any panels! No user-serviceable parts inside!

Always turn the heater OFF and unplug power cord from the outlet before cleaning, performing maintenance, or moving this fireplace. Failure to do so could result in electric shock, fire, or personal injury.

Electrical and Moving Parts:

- The fan motors are lubricated at the factory and do not require additional lubrication.
- Electrical components are integrated into the fireplace and are not serviceable by the consumer.

Storage:

- Store the fireplace in a clean, dry place when not in use.



WARNING! NO SERVICING of the internal or electrical parts should be performed by the consumer.

Replacement Parts List

REF.	SPARE PARTS, PART NUMBERS	OR52-Slim	OR60-Slim	OR76-Slim	OR100-Slim
1	Virtual Screen Back Plate	02-00496	02-00497	02-00498	02-00499
2	Virtual Screen	01-00100			
3	Middle Virtual Support	02-00493			
4	Top Virtual Support	02-00492			
5	Bottom Virtual Support	02-00491			
6	Side Virtual Support	02-00494			
7	Touch-on Control Panel	01-00109			
8	Mirror Glass, Displays	04-00038	04-00039	04-00040	04-00041
9	Bottom Glass Bracket	02-00474	02-00475	02-00476	02-00477
10	LED Downlight Bracket	02-00487	02-00488	02-00489	02-00490
11	Front Glass	04-00034	04-00035	04-00036	04-00037
12	Top Glass Bracket	02-00478	02-00479	02-00480	02-00481
13	Ember Bed Bracket	02-00482	02-00483	02-00484	02-00485
14	Interior Wall	02-00495			
15	Touch-on Control Bracket	02-00486			
16	Acrylic Ember Bed	03-00075	03-00076	03-00077	03-00078
17	Trim	02-00470	02-00471	02-00472	02-00473
18	LED Downlight Strip	01-00119			
19	USB Receiver	01-00112			
20	Main Power Switch	01-00113			
21	LED Ember Bed Strip	01-00117			
22	Internal Power Plate	02-00502			
23	External Power Plate	02-00503			
24	Side Skirt	02-00500			
25	Processor Board	01-00103			
26	Virtual Screen Drive Board	01-00101			
27	Virtual Breakout Board	01-00102			
28	Blower	01-00116			
29	Heater Mount	02-00501			
30	Speaker	01-00111			

Replacement Parts List (Continued)

REF.	SPARE PARTS, PART NUMBERS	OR52-Slim	OR60-Slim	OR76-Slim	OR100-Slim	
31	Wall Bracket (Rear)	02-00400	02-00401	02-00402	02-00403	
32	Main Circuit Board	01-00106				
33	Power Board	01-00104		01-00105		
34	Thermostat	01-00121				
35	Speaker Board	01-00107				
36	Heater	01-00115				
37	Remote	01-00110				
38	Smoked Crushed Glass	04-00042				
39	Hardware Kit	09-00007				
40	Power Cord	01-00118				
41	Memory Stick	01-00122				
42	Log, Orion, 1	05-00065				
43	Log, Orion, 2	05-00066				
44	Log, Orion, 3	05-00067				
45	Log, Orion, 4	N/A			05-00068	
46	Log, Orion, 5	05-00069				
47	Log, Orion, 6	05-00070				
48	Log, Orion, 7	N/A	05-00071			
49	Log, Orion, 8	05-00072				
50	Log, Orion, 9	05-00073				
51	Log, Orion, 10	N/A			05-00074	
52	Log, Orion, 11	N/A			05-00075	
53	Log, Orion, 12	N/A		05-00076		
54	Log, Orion, 13	N/A		05-00077		
55	Log, Orion, 14	05-00078				
56	Log, Orion, 15	N/A	05-00079			
57	Log, Orion, 16	N/A		05-00080		
58	Log, Orion, 18	N/A			05-00082	

Troubleshooting / FAQ



Turn off the appliance completely and let it cool down before servicing. Only a qualified service person should service and repair this electric appliance.

Symptom	Problem	Solution
Fireplace will not come on when power button/switch is put into the ON position.	Appliance is not plugged into an electrical outlet.	Check plug. Plug in the fireplace if necessary.
	Hardwire connections are not correct.	See "Hardwiring Installation" section.
	Appliance has overheated and the safety thermal switch has been tripped.	Unplug power or turn off the circuit breaker. Allow fireplace to cool for 15 minutes and then plug in the fireplace or turn the breaker back on.
	Main PCB board issue.	Inspect circuit boards for loose connections or obvious damage. Call Modern Flames Customer Service for support (1-877-246-9353)
	Fireplace has not fully turned on.	Allow 20-30 seconds for the fireplace to fully turn on.
	House circuit breaker not in "ON" position.	Inspect circuit breaker. Turn breaker to "ON" position.
Fireplace turns off and will not turn on.	House circuit breaker has tripped.	Reset the house circuit breaker.
	Fireplace's fuse has blown.	Inspect circuit boards for loose connections or obvious damage. Call Modern Flames Customer Service for support (1-877-246-9353)
	Fireplace has overheated and the safety thermal switch has tripped.	Unplug power or turn off the circuit breaker. Allow fireplace to cool for 15 minutes and then plug in the fireplace or turn the breaker back on.
Remote control does not work.	Low/dead batteries.	Replace the batteries in the remote control.
	Remote receiver malfunction.	Ensure the remote receiver is not blocked. Replace touch-on control panel if necessary.
No warm air coming out of the fireplace.	Heater setting is not selected.	See "Operation" section.
	Heater has been locked out.	See "Operation" section.
	Room temperature is higher than fireplace setting (if not set to room temperature).	Reset temperature setting.
	Fireplace has overheated and safety thermal switch has tripped.	Unplug power or turn off the circuit breaker. Allow fireplace to cool for 15 minutes and then plug in the fireplace or turn the breaker back on.
	Hardwire connections are not correct.	See "Hardwiring Installation" section.
	Heater issue.	Inspect the blower and heater. Replace if necessary.
Heater shuts off automatically.	Room is too warm.	The heater has a built-in thermostat. It will shut off automatically once the pre-set temperature has been reached. It will turn on automatically if the room temperature drops below the pre-set temperature.

Troubleshooting / FAQ (Continued)

Symptom	Problem	Solution
Dim or no flame.	Flame LCD issue.	Inspect the LCD and replace if necessary.
	Main PCB board issue.	Inspect circuit boards for loose connections or obvious damage. Call Modern Flames Customer Service for support (1-877-246-9353)
Ember bed is dim or not glowing.	Brightness is not selected.	See "Operation" section.
	Ember bed LED issue.	Inspect circuit boards for loose connections or obvious damage. Call Modern Flames Customer Service for support (1-877-246-9353)
	Main PCB board issue.	Inspect circuit boards for loose connections or obvious damage. Call Modern Flames Customer Service for support (1-877-246-9353)
No difference from setting H1 to H2.	Main PCB board issues.	Inspect circuit boards for loose connections or obvious damage. Call Modern Flames Customer Service for support (1-877-246-9353)
	Heating element issue.	Inspect circuit boards for loose connections or obvious damage. Call Modern Flames Customer Service for support (1-877-246-9353)
Error code "E1"	Thermostat issue.	Inspect circuit boards for loose connections or obvious damage. Call Modern Flames Customer Service for support (1-877-246-9353)

DO NOT RETURN TO STORE!



CALL US FIRST

For immediate help with installation, product information or if your product arrives damaged, please call our toll-free number at:

1-877-246-9353

(Monday – Friday, 8:00AM – 5:00PM, AZ Mountain Time)

Or email us at:

customerservice@modernflames.com

OUR STAFF IS READY TO PROVIDE ASSISTANCE

RPG BRANDS

RPG BRANDS FAMILY OF COMPANIES



customerservice@modernflames.com

modernflames.com