

NAPOLEON



ASCENT™ AND ACIES™ LINEAR SERIES GAS FIREPLACES
napoleonfireplaces.com



Ascent™ and Acies™ Linear Series Gas Fireplaces. Distinct Options.

Napoleon's Ascent™ Linear and Acies™ series boasts beauty and performance. These linear gas fireplaces can match any room décor or can be stylized to be a focal point in your room.

Their linear look is specifically designed to provide you with a sophisticated fire element that is perfect for both new building and renovation projects. They provide a complete luxurious experience delivered courtesy of the Divinity™ flame pattern. With the Acies™ Series you can double the enjoyment and double the statement you make in your home with the See Thru model.

Choose from a broad selection of designer options including surrounds, colored glass, river rocks, driftwood logs, media enhancement Kits and more!

Ascent™ Linear Series	4 - 9
Acies™ Series	10 - 15
Ascent™ Linear Series Features & Specifications.....	16 - 17
Acies™ Series Features & Specifications.....	18 - 19



Ascent™ Linear Series

Radiant Heat & Flame Innovation

The Napoleon Ascent™ Linear Series are perfect for homeowners, remodelers and custom builders. The Ascent™ Linear 36 and Ascent™ Linear 46 come standard with an exclusive Topaz CRYSTALINE™ ember bed that can be switched out to a completely new look and feel with the Shore Fire, Beach Fire and Mineral Rock Kits which include a variety of rocks, sand, logs and vermiculite.

Available Sizes:



36"

46"



Bluetooth®



Features



Optional Remote Controls



Topaz CRYSTALINE™ Ember Bed (included)



MIRRO-FLAME™ Porcelain Reflective Radiant Panels (Optional)



Optional Premium Blower



eFIRE controller application available free on iTunes and Google Play store

Mobile Device Controlled

Napoleon's eFIRE app will revolutionize the way you use your fireplace. We have cracked the code and present to you the first fireplace to be controlled by *Bluetooth*® technology, using an intuitive app on your mobile device. Napoleon's eFIRE app controls every function of your fireplace including; on/off, flame height and blower speed for total convenience.

(Optional for the Ascent™ Linear Series)

Style & Size Options

Various Models, Media Kits, Surrounds and Trims Shown



Black Standard Safety Barrier

Shown on Ascent™ Linear 36 with Shore Fire Media Kit



Black Standard Safety Barrier

Shown on Ascent™ Linear 46 with Shore and Beach Fire Kits combined



Black Standard Safety Barrier

Shown on Ascent™ Linear 36 with Topaz Glass Embers (included)



Classic Black Surround

Shown on Ascent™ Linear 36 with Beach Fire and Mineral Rock Kits combined on Clear Glass Beads



Classic Black Surround

Shown on Ascent™ Linear 46 with Mineral Rock Kit on Black Glass Embers



Classic Black Surround

Shown on Ascent™ Linear 36 with Shore Fire Kit



Premium Brushed Stainless Steel Surround

Shown on Ascent™ Linear 36 with Beach Fire Kit on Amber Glass Embers



Premium Brushed Stainless Steel Surround

Shown on Ascent™ Linear 46 with Clear Glass Beads



Premium Brushed Stainless Steel Surround

Shown on Ascent™ Linear 36 with Mineral Rock Kit on Topaz Glass Embers

Media Options

Mineral Rock Kits on Topaz Glass Embers



Media Options

Beach Fire and Shore Fire Kits Combined



Beach Fire Kit



Shore Fire Kit (sand included)



Beach Fire, Shore Fire and Mineral Rock Kits combined



Topaz Glass Embers



Clear Glass Beads



Beach Fire Kit on Topaz Glass Embers



MIRRO-FLAME Porcelain Reflective Radiant Panels



AMBIENT-GLOW Ember enhancing Metal Fibers



Blue Glass Embers



Amber Glass Embers



Black Glass Embers



Red Glass Embers



Topaz Glass Embers (Included)



Clear Glass Embers



Blue Glass Beads



Amber Glass Beads



Black Glass Beads



Red Glass Beads

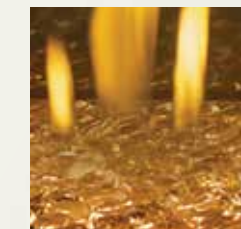

Topaz Glass Beads



Clear Glass Beads

Ascent™ Linear 36



Ascent™ Linear 36 - Black Standard Safety Barrier



Ascent™ Linear 36 - Premium Brushed Stainless Steel Surround



Ascent™ Linear 36 - Classic Black Surround

BL36-1

Up to 17,500 BTU's

Viewing Area: 18 13/16" h x 31 9/16" w

For more detailed specifications on this unit, see page 16

Ascent™ Linear 46

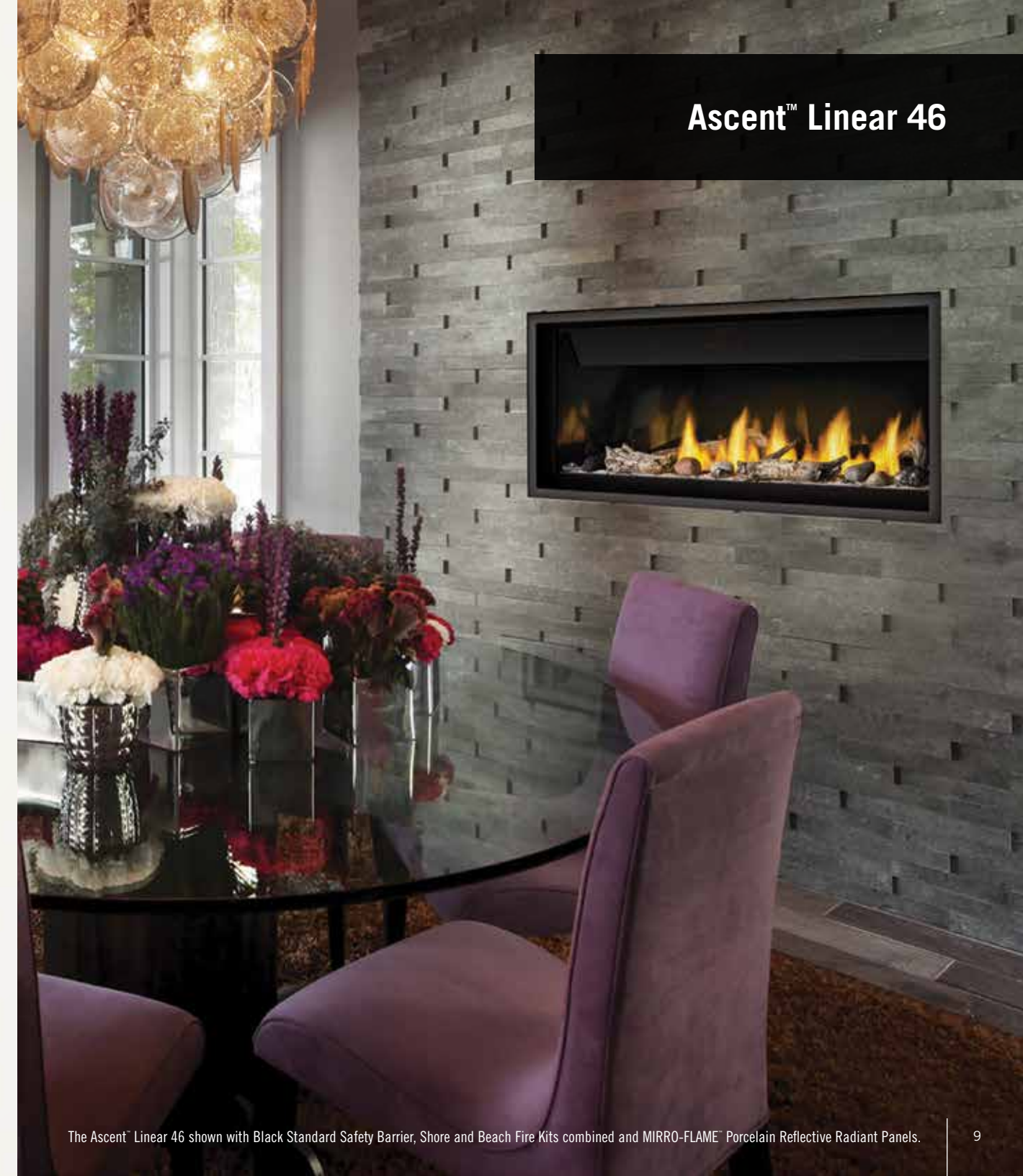

Ascent™ Linear 46 - Black Standard Safety Barrier



Ascent™ Linear 46 - Premium Brushed Stainless Steel Surround



Ascent™ Linear 46 - Classic Black Surround

BL46

Up to 24,000 BTU's

Viewing Area: 18 13/16" h x 42 1/2" w

For more detailed specifications on this unit, see page 16

Acies™ Series

Breathtaking Ambiance

With a sleek linear design and a multitude of designer options, Napoleon's Acies™ series gas fireplaces provide a complete luxurious experience delivered courtesy of their new Divinity™ flame pattern. Available as a single sided or a two sided See Thru model, the radiant glow is enjoyed through the CRYSTALINE™ ember bed with the option of adding Beach Fire, Shore Fire, Mineral Rock media enhancement kits and more!

Available Sizes:

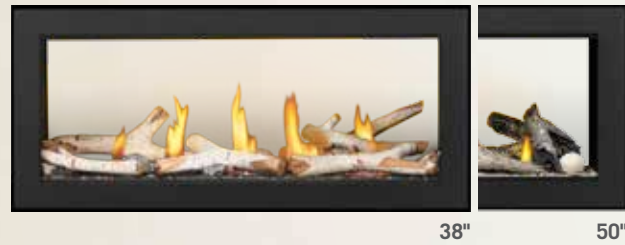

Features



Optional Remote Controls



Topaz CRYSTALINE™ Ember Bed (included)



MIRRO-FLAME™ Porcelain Reflective Radiant Panels (Optional)



eFIRE controller application available free on iTunes and Google Play store

Mobile Device Controlled

Napoleon's eFIRE app will revolutionize the way you use your fireplace. We have cracked the code and present to you the first fireplace to be controlled by *Bluetooth*® technology, using an intuitive app on your mobile device. Napoleon's eFIRE app controls every function of your fireplace including; on/off, flame height and blower speed for total convenience.

(Optional for the Acies™ Linear Series)

Style & Size Options

Various Models, Media Kits, Surrounds and Trims Shown



Black Standard Safety Barrier

Shown on Single Sided Acies™ 38 with Topaz Glass Embers

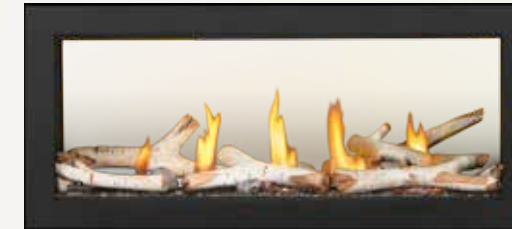

Black Standard Safety Barrier

Shown on See Thru Acies™ 38 with Birch Logs on Topaz Glass Embers



Black Standard Safety Barrier

Shown on Single Sided Acies™ 50 with Shore and Beach Fire Kits combined



Brushed Stainless Steel Surround and 1" Finishing Trim

Shown on See Thru Acies™ 38 with Topaz Glass Embers



Classic Black Surround and 1" Finishing Trim

Shown on Single Sided Acies™ 38 with Topaz Glass Embers



Brushed Stainless Steel Surround

Shown on See Thru Acies™ 50 with Topaz Glass Embers



Black Standard Safety Barrier

Shown on Single Sided Acies™ 38 with Birch Logs on Topaz Glass Embers



Brushed Stainless Steel Surround

Shown on See Thru Acies™ 38 with Beach and Shore Fire Kits combined



Classic Black Surround

Shown on Single Sided Acies™ 50 with Mineral Rock Kit on Topaz Glass Embers

Media Options

Premium Birch Log Kit with Mineral Rock Kit on Topaz Glass Embers



Media Options

Nickel Stix on Topaz Glass Embers



Beach Fire and Shore Fire Kits Combined



Shore Fire Kit (sand included)



Mineral Rock Kit



Topaz Glass Embers



Clear Glass Beads



Beach Fire Kit on Topaz Glass Embers



MIRRO-FLAME Porcelain Reflective Radiant Panels



AMBIENT-GLOW Ember Enhancing Metal Fibers



Blue Glass Embers



Amber Glass Embers



Black Glass Embers



Red Glass Embers



Topaz Glass Embers (Included)



Clear Glass Embers



Blue Glass Beads

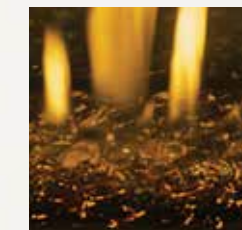

Amber Glass Beads



Black Glass Beads



Red Glass Beads



Topaz Glass Beads



Clear Glass Beads

Acies™ 38

Single-Sided & See Thru Models

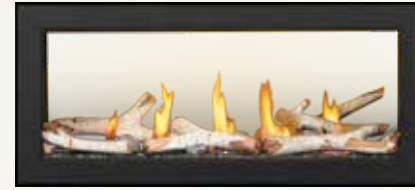

Acies™ 38 - Black Standard Safety Barrier



Acies™ 38 - Black Standard Safety Barrier



Acies™ 38 - Brushed Stainless Steel Surround



Acies™ 38 - Classic Black Surround and 1" Finishing Trim

L38N / L38N2

Up to 24,000 BTU's

Viewing Area: 18 13/16" h x 40 3/4" w

For more detailed specifications on this unit, see page 18



Acies™ 50 - Black Standard Safety Barrier



Acies™ 50 - Black Standard Safety Barrier



Acies™ 50 - Brushed Stainless Steel Surround



Acies™ 50 - Classic Black Surround

L50N / L50N2

Up to 30,000 BTU's

Viewing Area: 18 13/16" h x 52 3/4" w

For more detailed specifications on this unit, see page 18

Acies™ 50

Single-Sided & See Thru Models



The See Thru Acies™ 50 shown with Classic Black Surround, Beach and Shore Fire Kits combined.

The See Thru Acies™ 38 shown with Black Standard Safety Barrier, Birch Logs and Shore Fire Kits combined.

Ascent™ Linear Series

Product Features

- Clean face design with high quality safety barrier included
- Available in Natural Gas and Propane
- SIT Proflame II system (remote control not included)
- Optimized burner performance (for all vent and fuel configurations)
- Includes **CRYSTALINE™** topaz glass ember bed
- **Divinity™** flame pattern provides heightened peaks and valleys
- Non-combustible material included, no steel framing required
- Easy access air control for fast and precise air shutter adjustments
- Fuel saving electronic ignition with battery back-up

- Electronic Ignition including High/Low Flame adjustment
- Optional **MIRRO-FLAME™** Porcelain Reflective Radiant Panels available
- Low profile optional surrounds available in black and stainless steel
- Optional media includes: Mineral Rock Kit, Shore Fire Kit and Beach Fire Kits, Glass Embers and Glass Beads in various colors!
- Optional blower Kits available
- **eFIRE** App allows you to customize your enjoyment with the convenience of your mobile device (optional)
- Manual high/low flame adjustment



Ascent™ Linear Series

Dimensions & Specifications

BL36-1

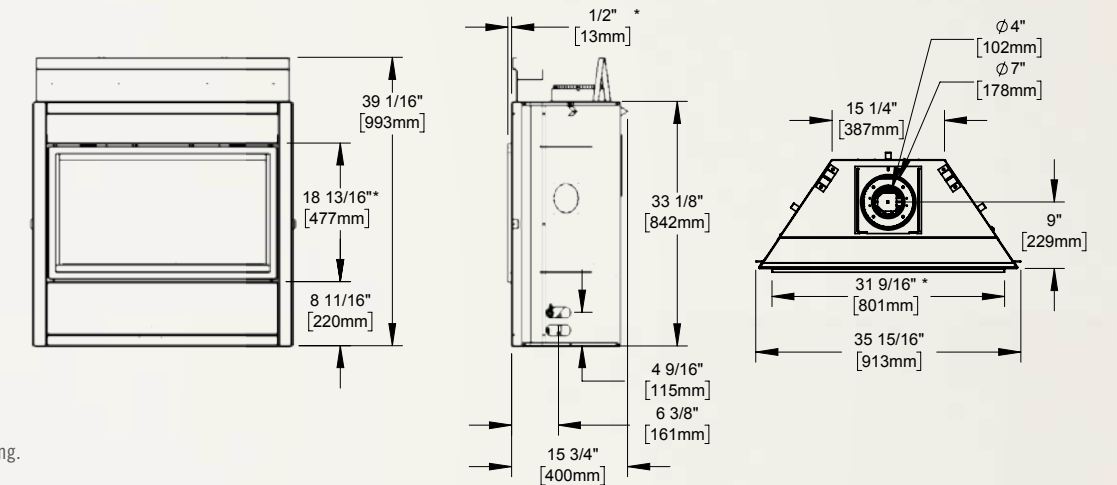

*Finishing flange depth (The finishing flange defines the perimeter of the fireplace opening. Framing or finishing materials must **NEVER** encroach inside the finishing flange).

Product Code	BTU's (Input)	Venting 4" / 7"	Height		Width		Depth		Viewing Area		Efficiency P4
			Actual	Framing	Actual	Framing	Actual	Framing	Height	Width	
BL36-1	17,500	Top	39 1/16"	39 3/8"	35 15/16"	36 1/2"	15 11/16"	16"	18 13/16"	31 9/16"	51.7%

BL46

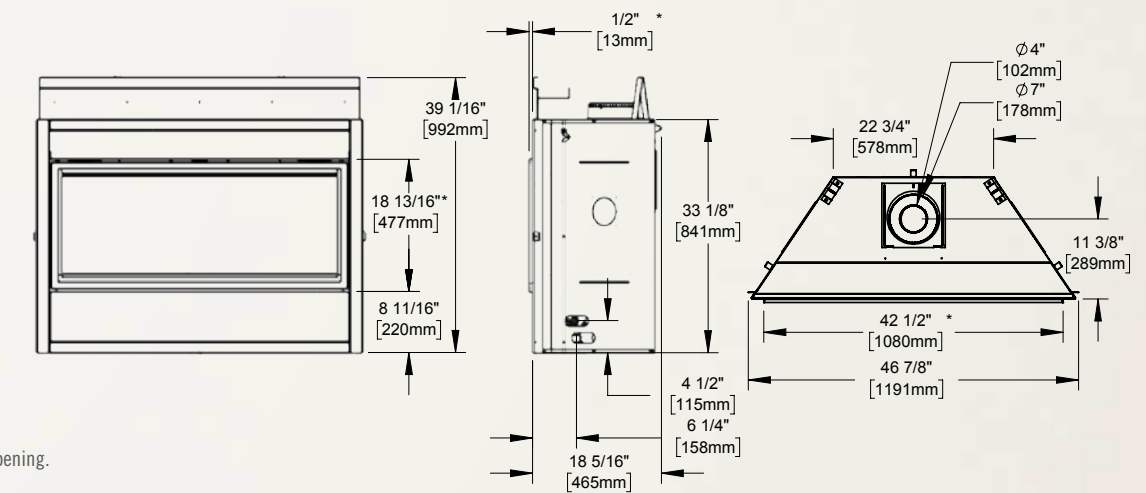

*Finishing flange depth (The finishing flange defines the perimeter of the fireplace opening. Framing or finishing materials must **NEVER** encroach inside the finishing flange).

Product Code	BTU's (Input)	Venting 4" / 7"	Height		Width		Depth		Viewing Area		Efficiency P4
			Actual	Framing	Actual	Framing	Actual	Framing	Height	Width	
BL46	24,000	Top	39 1/16"	39 3/8"	46 7/8"	47 3/8"	18 5/16"	18 9/16"	18 13/16"	42 1/2"	50.3%

Acies™ Series

Product Features

- Black Standard Safety Barrier included
- Available in Natural Gas and Propane
- New Premium Birch Log Kit available
- SIT Proflame II system (remote not included)
- Includes **CRYSTALLINE™** topaz glass ember bed
- **Divinity™** flame pattern provides heightened peaks and valleys
- Easy access air control for fast and precise air shutter adjustments
- Fuel saving electronic ignition with battery back-up

- Electronic Ignition
- Manual High/Low Flame adjustment
- Optional **MIRRO-FLAME™** Porcelain Reflective Radiant Panels available
- Low profile optional surrounds and 1" Finishing Trims available in black and stainless steel
- Optional media includes: Nickel Stix, Mineral Rock Kit, Shore Fire Kit and Beach Fire Kits, Glass Embers and Glass Beads in various colors!
- **eFIRE** App allows you to customize your enjoyment at the convenience of your mobile device (optional)

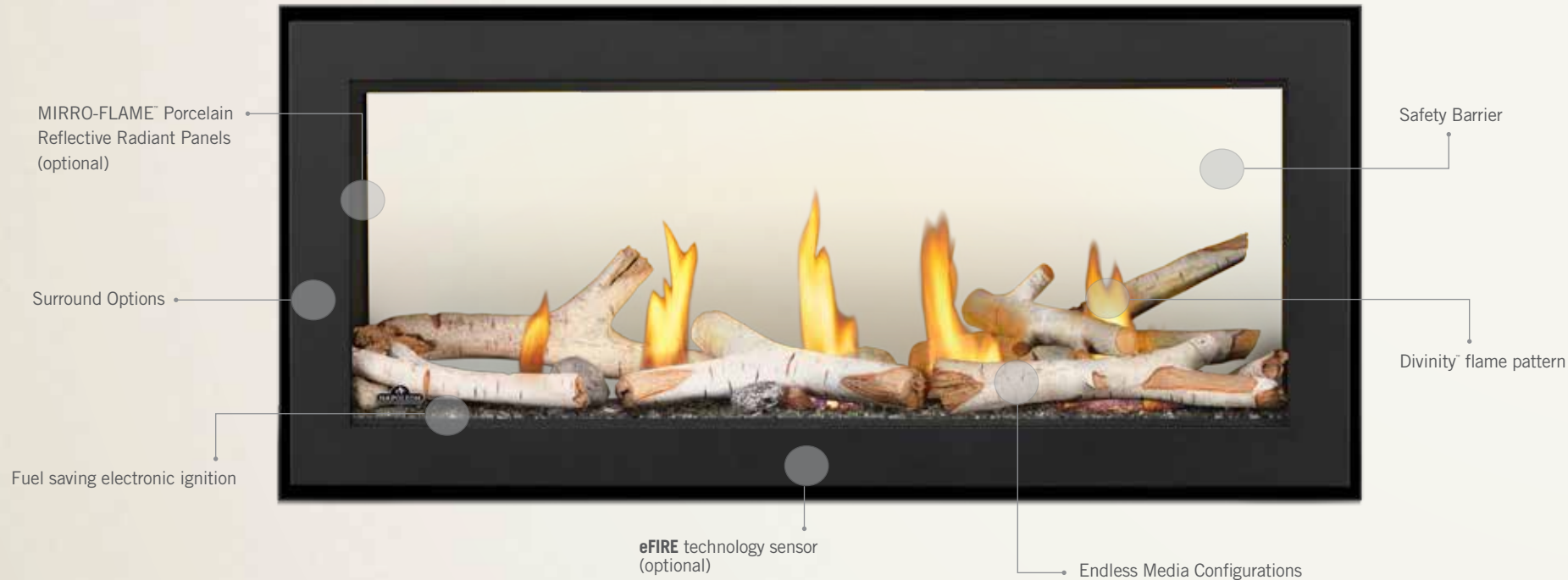

Acies™ Series

Dimensions & Specifications

Single Sided Model

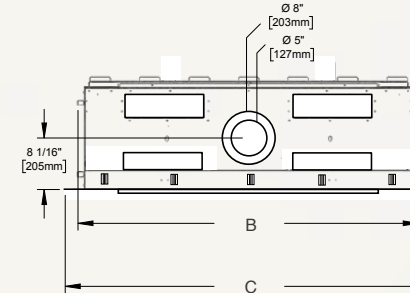
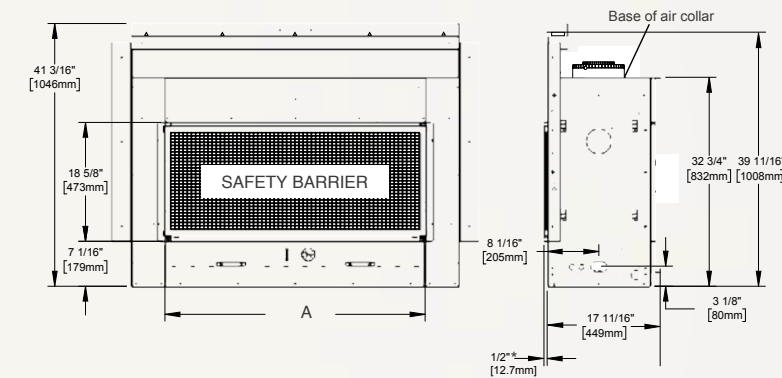

	CL38	CL50
A	40 3/4"	52 3/4"
(Finishing Flange)	(1035mm)	(1340mm)
B	53 5/16"	65 5/16"
	(1354mm)	(1659mm)
C	57 5/16"	69 5/16"
	(1456mm)	(1761mm)

*Finishing flange depth (The finishing flange defines the perimeter of the fireplace opening. Framing or finishing materials must **NEVER** encroach inside the finishing flange).

See Thru Model

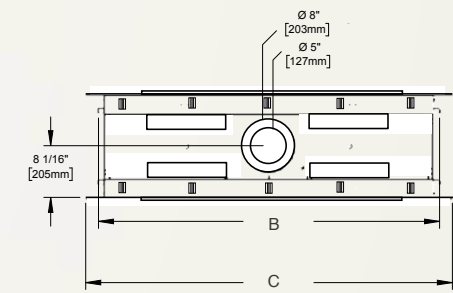
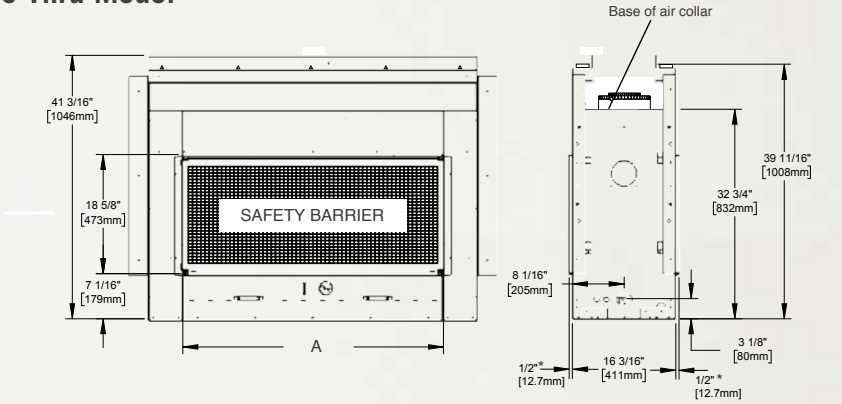

	CL38	CL50
A	40 3/4"	52 3/4"
(Finishing Flange)	(1035mm)	(1340mm)
B	53 5/16"	65 5/16"
	(1354mm)	(1659mm)
C	57 5/16"	69 5/16"
	(1456mm)	(1761mm)

*Finishing flange depth (The finishing flange defines the perimeter of the fireplace opening. Framing or finishing materials must **NEVER** encroach inside the finishing flange).

Product Code	BTU's (Input)	Venting 5" / 8"	Height		Width		Depth		Glass Size		Efficiency P4
			Actual	Framing	Actual	Framing	Actual	Framing	Height	Width	
L38N (Single Sided)	24,000	Top	39 11/16"	39 15/16"	53 5/16"	53 13/16"	17 11/16"	18"	18 5/8"	40 3/4"	38.5%
L38N2 (See Thru)	24,000	Top	39 11/16"	39 15/16"	53 5/16"	53 13/16"	16 3/16"	16 3/16"	18 5/8"	40 3/4"	38.5%
L50N (Single Sided)	30,000	Top	39 11/16"	39 15/16"	65 5/16"	65 13/16"	17 11/16"	18"	18 5/8"	52 3/4"	45.3%
L50N2 (See Thru)	30,000	Top	39 11/16"	39 15/16"	65 5/16"	65 13/16"	16 3/16"	16 3/16"	18 5/8"	52 3/4"	45.3%



NAPOLEON - CELEBRATING OVER 40 YEARS OF HOME COMFORT PRODUCTS



24 Napoleon Road, Barrie, Ontario, Canada L4M 0G8
103 Miller Drive, Crittenden, Kentucky, USA 41030
7200 Trans Canada Highway, Montreal, Quebec, Canada H4T 1A3

Tel: 1-866-820-8686
napoleonfireplaces.com

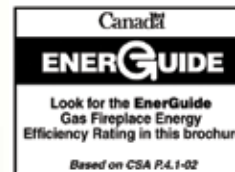

Authorized Dealer

Consult your owner's manual for complete installation instructions and proper clearances to combustible materials. Check all local and national building codes and gas regulations. All specifications are subject to change without prior notice due to on-going product improvements. Products may not be exactly as shown. Flame height and activity is influenced by varying vent configurations and may not appear as shown. Napoleon® is a registered trademark of Wolf Steel Ltd. © Wolf Steel Ltd. EnerGuide - A Canadian efficiency standard based on frequent, short start-up and cool-down cycles. All appliances sold in Canada are subject to this EnerGuide rating system. AFUE - A US efficiency standard (Department of Energy) based on extended on/off cycles, more typical of fireplace usage. Steady State - Reflects the highest possible overall heating efficiency.