



**BROMIC**<sup>®</sup>  
HEATING



# ECLIPSE SMART-HEAT™ ELECTRIC

Reimagine the outdoors with our Eclipse Smart-Heat™ series. Available in seven unique designs, the Bromic Eclipse series adds style, warmth and light to design-focused outdoor spaces.



ECLIPSE ELECTRIC PORTABLE



24" TWIN CEILING MOUNT POLE



24" STRAIGHT CEILING MOUNT POLE



WALL MOUNT

ECLIPSE  
**SMART-HEAT™ ELECTRIC  
PORTABLE**

---

Add warmth and comfort to outdoor spaces while striking the perfect balance between ambience, style, and functionality with our Eclipse Smart-Heat™ Electric Portable Heater.





## ECLIPSE SMART-HEAT™ ELECTRIC

Dim the lights and turn up the heat with our Eclipse Smart-Heat™ Electric heater. Available in six unique mounting options, the new Bromic Eclipse Smart-Heat™ Electric series brings comfort, light and style to commercial and residential outdoor spaces.

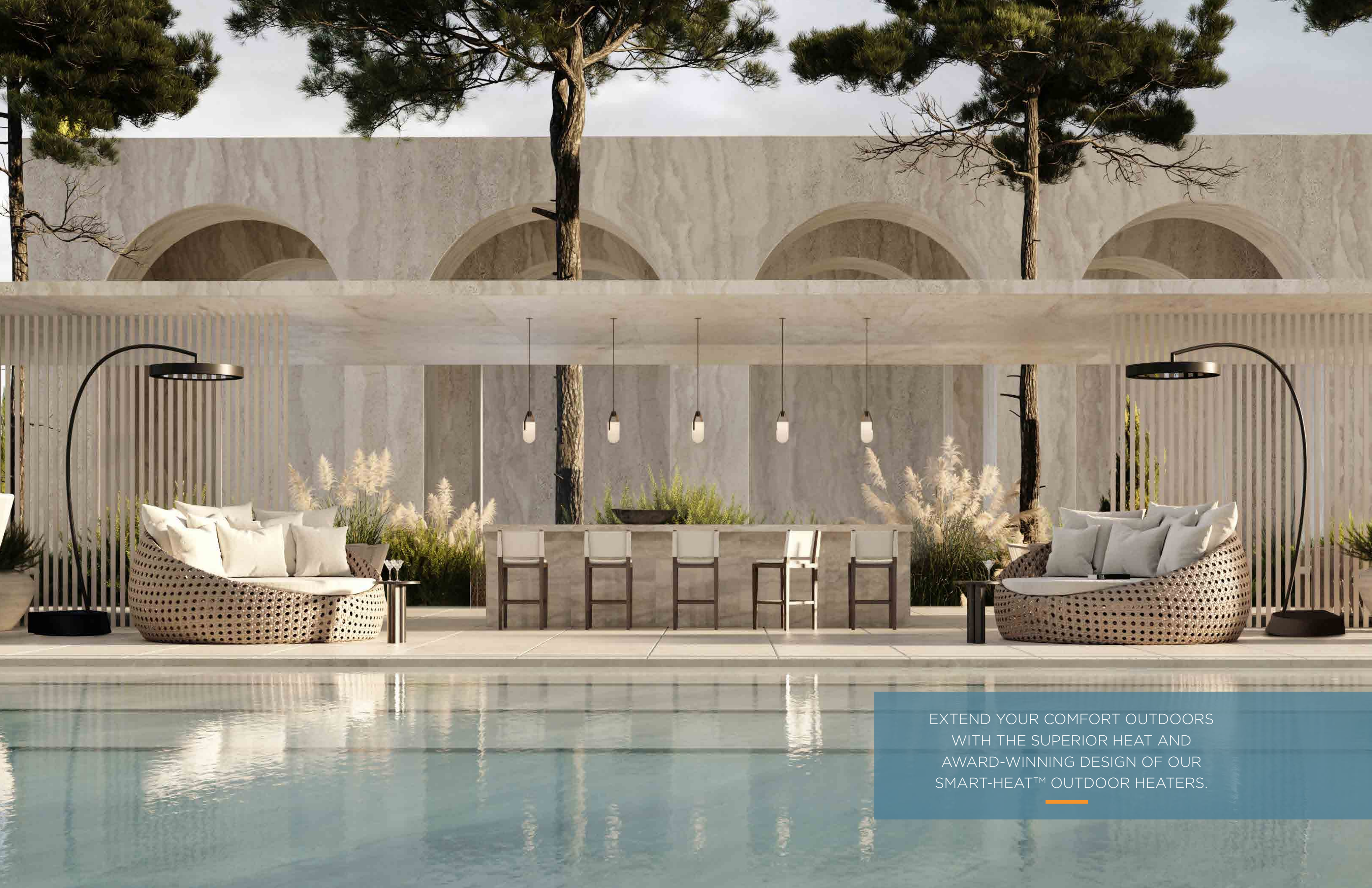

EXTEND YOUR COMFORT OUTDOORS  
WITH THE SUPERIOR HEAT AND  
AWARD-WINNING DESIGN OF OUR  
SMART-HEAT™ OUTDOOR HEATERS.

SEAMLESS INTEGRATION OF  
MODERN CLEAN LINES, MINIMALISTIC  
DESIGN AND QUALITY MATERIALS  
ACHIEVES INNOVATIVE STYLING AND  
TECHNICAL PERFORMANCE.

---

BRÖMIC

PLATINUM SMART-HEAT™ ELECTRIC  
WITH OPTIONAL RECESS KIT

PLATINUM  
SMART-HEAT™ ELECTRIC

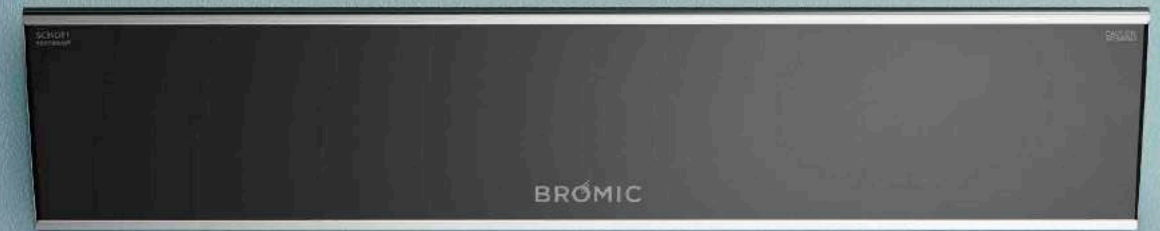
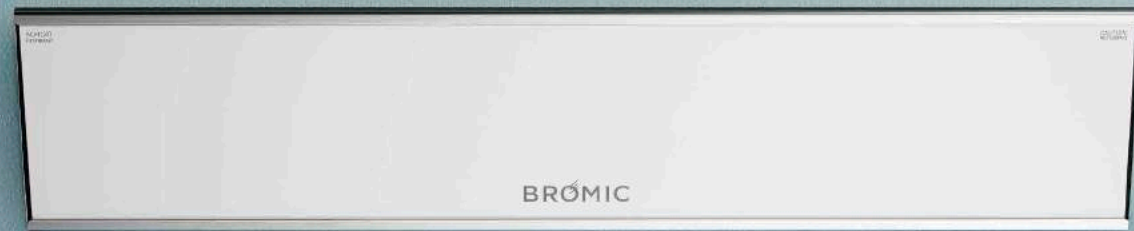
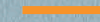

Available in black and white, our Platinum Smart-Heat™ Electric heater is specifically suited for low-clearance and design-focused spaces. This slim-line, stainless-steel unit spreads comfort evenly, all while minimizing light emission and blending seamlessly into the background with our recess mounting solutions. The Platinum Electric range is also available in a marine-grade 316 stainless steel for extra longevity in coastal and marine environments.





PLATINUM  
SMART-HEAT™ GAS

---



The Platinum Smart-Heat™ Gas heater series spreads heat and comfort evenly in all areas, with a soft and soothing red glow. Built with pure premium materials and designed with elegance, there is no compromise on performance, reliability and beauty.

TUNGSTEN  
SMART-HEAT™ ELECTRIC

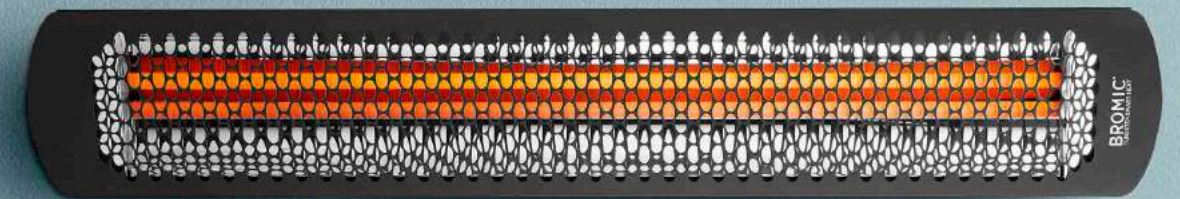

Our Tungsten Smart-Heat™ Electric series offers high performance radiant heating for outdoor and semi-enclosed spaces alike, with an industrial design style. It also boasts a high-temperature coating to suit all environments. With a stainless-steel construction, its durable element will emit a soft red glow to create a warm ambience in your space.

**BROMIC**  
TUNGSTEN SMART-HEAT

TUNGSTEN  
SMART-HEAT™ GAS

---

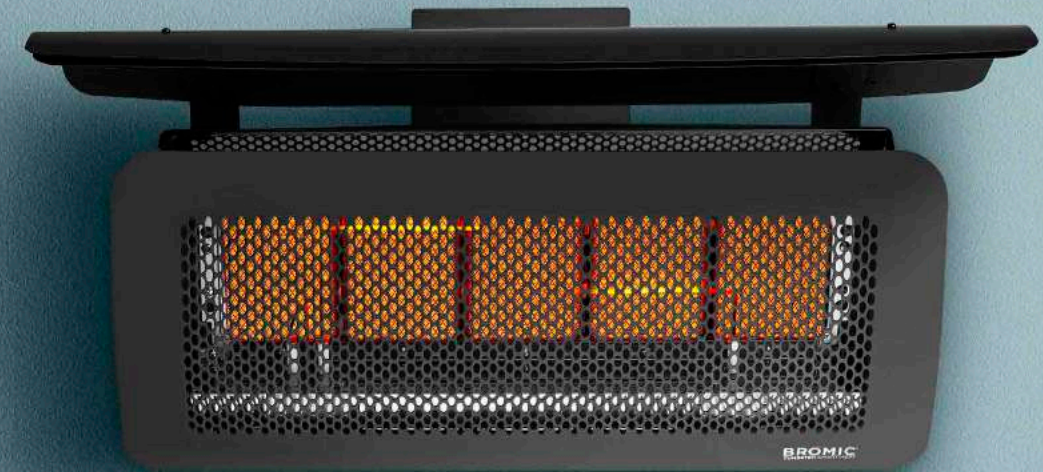

Our Tungsten Smart-Heat™ Gas heater has a durable, soft flowing curved facia and engineered body, which produces formidable heat to create a truly comfortable outdoor space. Its easy pivot arm allows for greater positioning and directional heat control. This heater also has a range of accessories available to provide versatility in mounting & controller options.



EXTEND YOUR COMFORT OUTDOORS  
WITH THE SUPERIOR HEAT AND  
AWARD-WINNING DESIGN OF OUR  
SMART-HEAT™ OUTDOOR HEATERS.



## TUNGSTEN SMART-HEAT™ PORTABLE

---

Its neutral black finish and award-winning design make it a piece of modern art. The Tungsten Smart-Heat™ Portable heater offers efficient directional heat and is a versatile heating solution for any outdoor settings. Its modular construction with built-in wheels allows for easy maneuverability in tighter spaces.

**SWITCH ON.  
GO WIRELESS.**

## SMART-HEAT™ WIRELESS CONTROLLERS

With the option to connect groups of heaters from a single point as well as dimming heating outputs, the Smart-Heat™ range of controllers provide a simple, yet powerful solution to controlling your environment.



**ON | OFF 4-CHANNEL  
REMOTE CONTROLLER\***  
(GAS & ELECTRIC)

The Bromic Smart-Heat Wireless On | Off Controller can switch power supply to two separate outputs, enabling independent 'On | Off' control without even having to move from your seat.



**DIMMER CONTROLLER\***  
(ELECTRIC ONLY)

The Bromic Smart-Heat™ Wireless Dimmer Controller allows you to adjust the heat from 1-100% for perfect comfort and complete flexibility.



**BROMIC  
SMART-HEAT™ LINK**

The Bromic Smart-Heat™ Link is compatible with some of the leading Home Automation systems, allowing you to easily control your Bromic outdoor heaters from your home automation control panel.\*\*

\*\* Requires RS232 plugin

\*Please contact a Bromic heating specialist to discuss the ideal solution for your outdoor space. Our free design service includes wiring diagrams for set up options.

# ECLIPSE SMART-HEAT™ ELECTRIC PORTABLE

## MODEL

PRODUCT CODE	BH0820001-1
FUEL TYPE	ELECTRIC (2900W)
COLOR	MATTE BLACK
MATERIAL (HEATER HEAD)	PREMIUM COATED 304 STAINLESS STEEL
MATERIAL (FREESTANDING FRAME)	PREMIUM, DOUBLE COATED STEEL
HEAT AREA	121FT <sup>2</sup>
LED COLOR	WARM WHITE - DIMMABLE
LED TEMPERATURE	3000K
LED LUMENS	216.6
RATED CURRENT & VOLTAGE	12.9 A (220V) / 13.5 A (230V) / 14.1 A (240V)
MINIMUM FLOOR CLEARANCE	79"

## MOUNTING OPTIONS

FREESTANDING	✓
--------------	---

## CONTROL OPTIONS

DIMMER CONTROL	INCLUDED
MASTER REMOTE ECLIPSE*	BH3623002-1 (OPTIONAL)

Measurements displayed within this catalog are minimum requirements for installation.  
Bromic takes no responsibility for incorrect or non-compliant installations.  
All measurements in this catalog are displayed in inches.

\*Control up to six zones of heaters with unlimited heaters per zone from a single remote.

## PRODUCT MEASUREMENTS

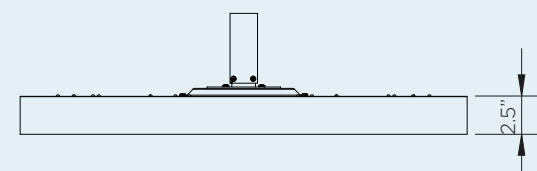
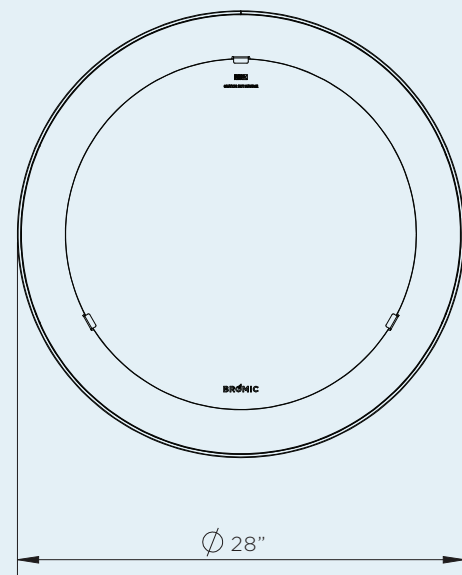

## FREESTANDING

FRONT VIEW

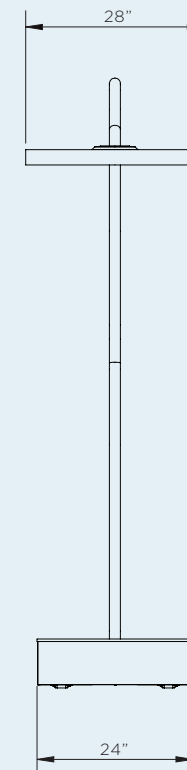

CEILING & WALL CLEARANCE

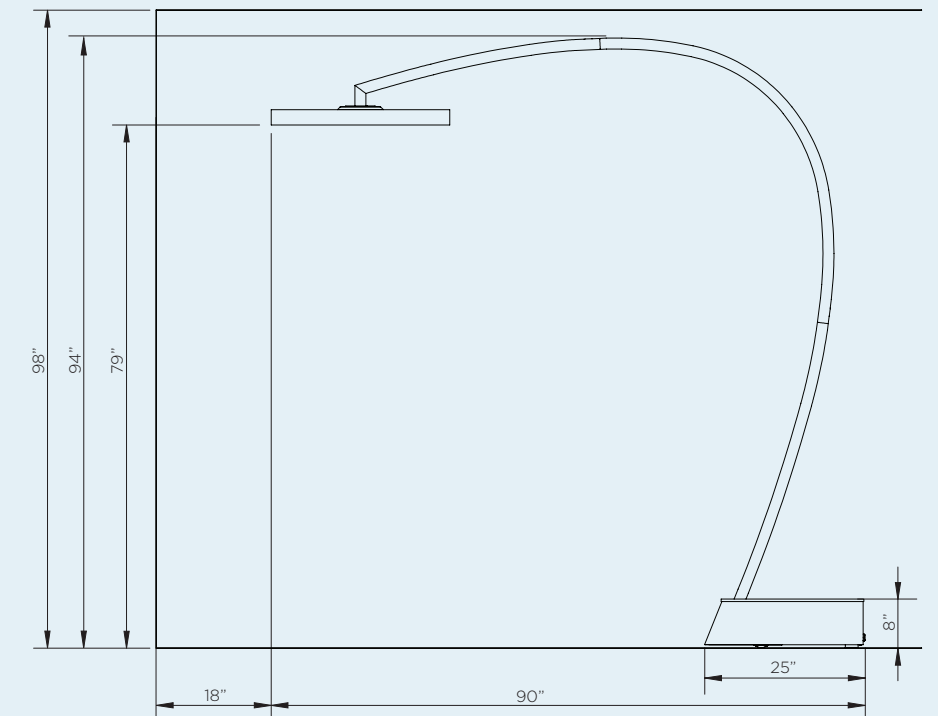

## HEAT AREA

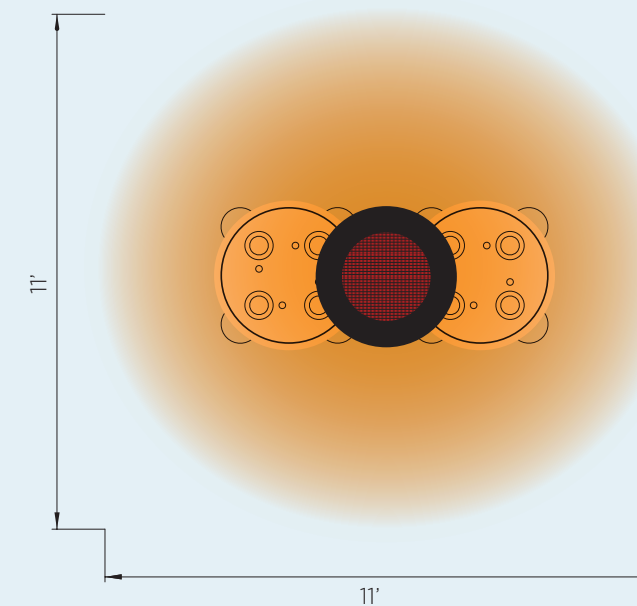

**2900W SERIES**  
HEATING APPROXIMATELY 121FT<sup>2</sup>  
2900W HEATING POWER

\*HEAT AREA DEPENDENT ON AMBIENT TEMPERATURE AND WIND. OPTIMUM CONDITIONS EXPERIENCED AT APPROX 60°F AND IN A LOW WIND COVERED ENVIRONMENT.



# ECLIPSE SMART-HEAT™ ELECTRIC PENDANT

## MODEL

PRODUCT CODE	BH0920001-1
FUEL TYPE	ELECTRIC (2900W)
COLOR	MATTE BLACK
MATERIAL (HEATER HEAD)	PREMIUM COATED 304 STAINLESS STEEL
MATERIAL (MOUNTING ARMS)	PREMIUM, DOUBLE COATED STEEL
HEAT AREA	121FT <sup>2</sup>
LED COLOR	WARM WHITE - DIMMABLE
LED TEMPERATURE	3000K
LED LUMENS	216.6
RATED CURRENT & VOLTAGE	12.9 A (220V) / 13.5 A (230V) / 14.1 A (240V)
MINIMUM FLOOR CLEARANCE	CEILING 96"   WALL 96"

## MOUNTING OPTIONS

WALL MOUNT	BH3230006 (OPTIONAL)
8" STRAIGHT CEILING MOUNT POLE	BH3230001 (OPTIONAL)
24" STRAIGHT CEILING MOUNT POLE	BH3230002 (OPTIONAL)
24" TWIN STRAIGHT CEILING MOUNT POLE	INCLUDED
24" CURVED CEILING MOUNT POLE	BH3230004 (OPTIONAL)
48" STRAIGHT CEILING MOUNT POLE	BH3230005 (OPTIONAL)

## CONTROL OPTIONS

DIMMER CONTROL	BH3230007-1 (RECOMMENDED)
MASTER REMOTE ECLIPSE*	BH3623002-1 (OPTIONAL)

Measurements displayed within this catalog are minimum requirements for installation. Bromic takes no responsibility for incorrect or non-compliant installations. All measurements in this catalog are displayed in inches.

\*Control up to six zones of heaters with unlimited heaters per zone from a single remote. Dimmer control required.

## PRODUCT MEASUREMENTS

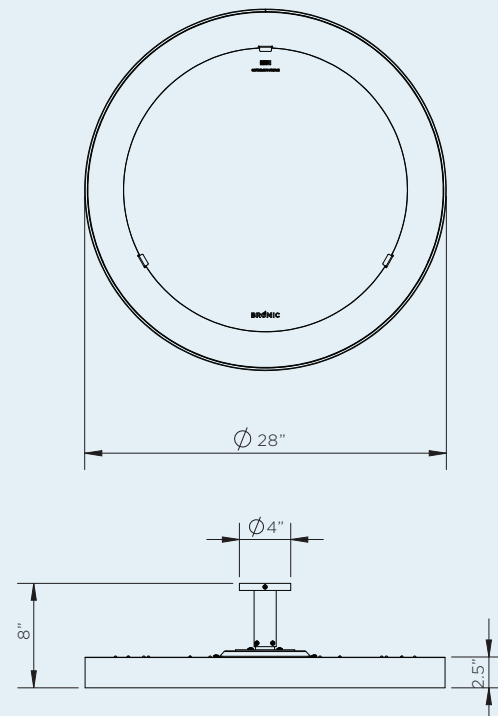

## CEILING MOUNTING OPTIONS

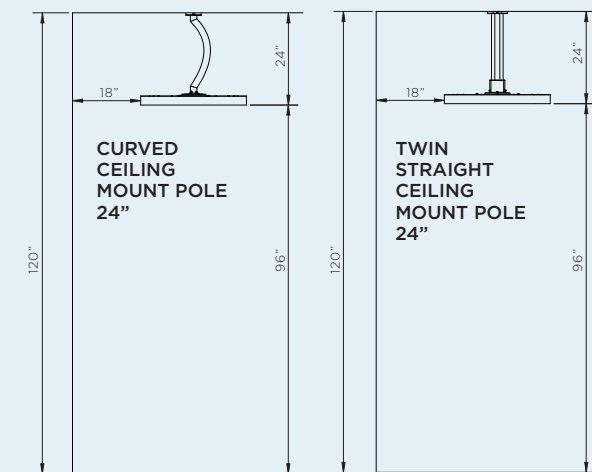
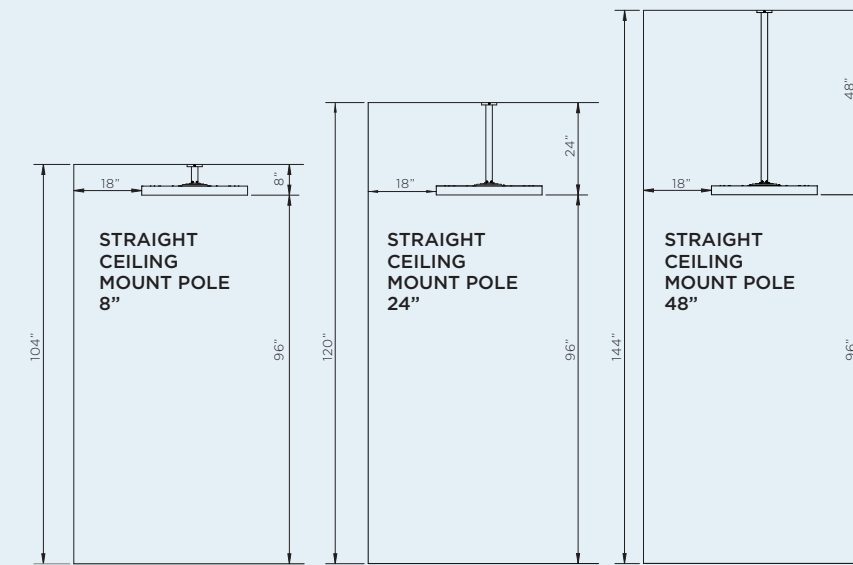

## WALL MOUNTING

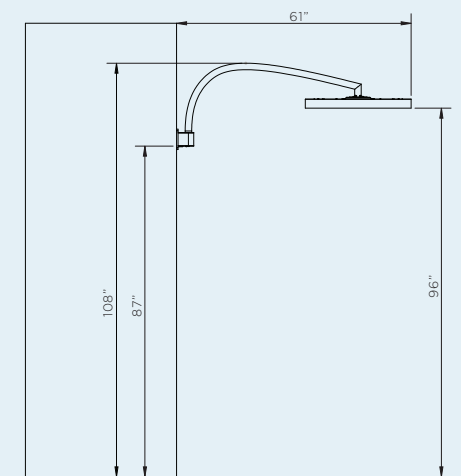

## HEAT AREA

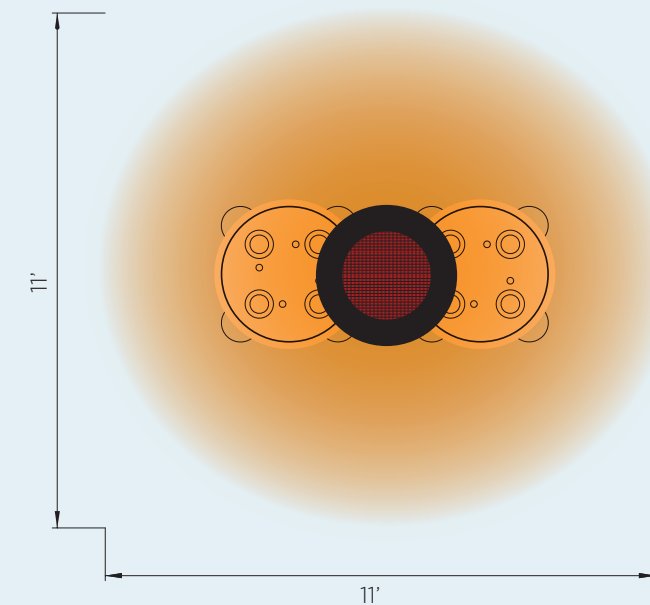

**2900W SERIES**  
HEATING APPROXIMATELY 121FT<sup>2</sup>  
2900W HEATING POWER

\*HEAT AREA DEPENDENT ON AMBIENT TEMPERATURE AND WIND. OPTIMUM CONDITIONS EXPERIENCED AT APPROX 60°F AND IN A LOW WIND COVERED ENVIRONMENT.

# PLATINUM SMART-HEAT™ GAS

MODEL NUMBER	300 SERIES	500 SERIES
PRODUCT CODE	BH0110002-1   BH0110001-1	BH0110004-1   BH0110003-1
FUEL TYPE	LPG   NG	LPG   NG
COLOR	BLACK   STAINLESS	BLACK   STAINLESS
HEAT AREA	160FT <sup>2</sup>	215FT <sup>2</sup>
RATED CURRENT	110V/2A	110V/2A
MINIMUM FLOOR CLEARANCE	96"	96"
OUTPUT	23,600 BTU	39,800 BTU

MOUNTING OPTIONS	300 SERIES	500 SERIES
CEILING MOUNT	✓	✓
WALL MOUNT	✓	✓
RECESSED   FLUSH MOUNT	-	-
CEILING POLE MOUNT	✓	✓
FREESTANDING	-	-

CONTROL OPTIONS	300 SERIES	500 SERIES
ON   OFF	✓	✓
ON   OFF PRODUCT CODE	BH3130010-1	BH3130010-1
DIMMER	-	-
MASTER REMOTE	-	-

Measurements displayed within this catalog are minimum requirements for installation. Bromic takes no responsibility for incorrect or non-compliant installations. All measurements in this catalogue are displayed in inches.

## PRODUCT MEASUREMENTS

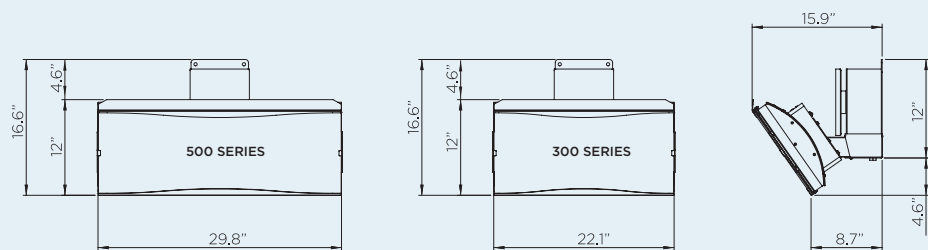

## PRODUCT MEASUREMENTS WITH HEAT DEFLECTOR

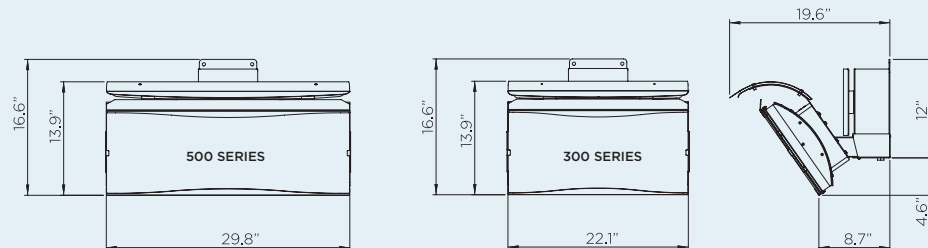

## CEILING & WALL MOUNT CLEARANCE

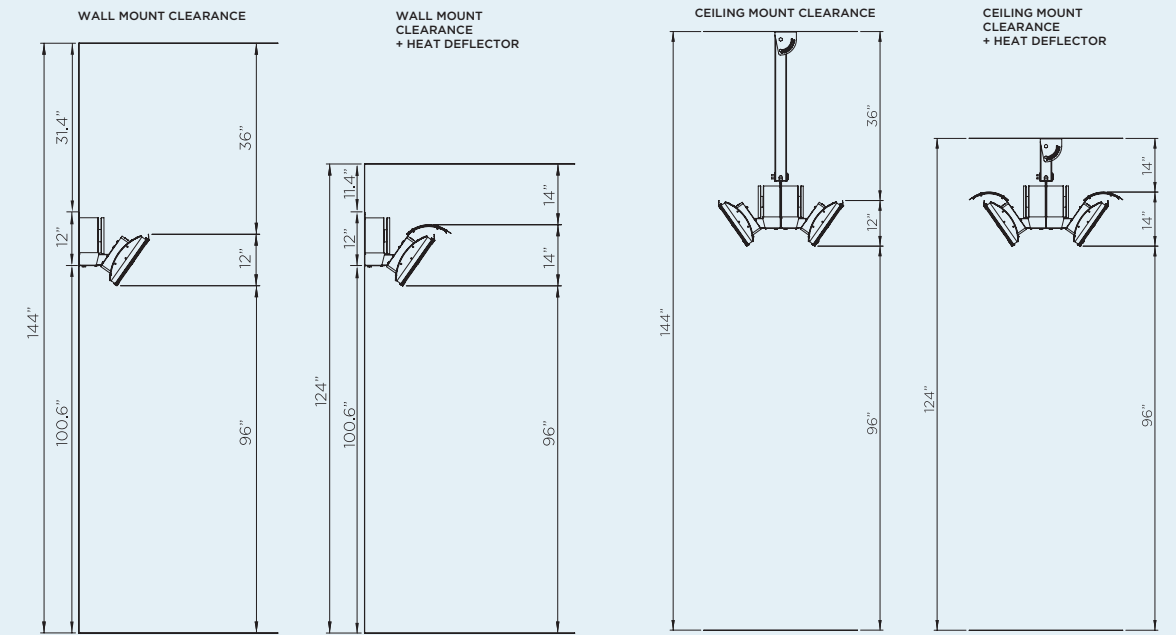

## WALL BRACKET

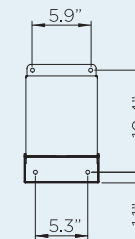

## HEAT AREA

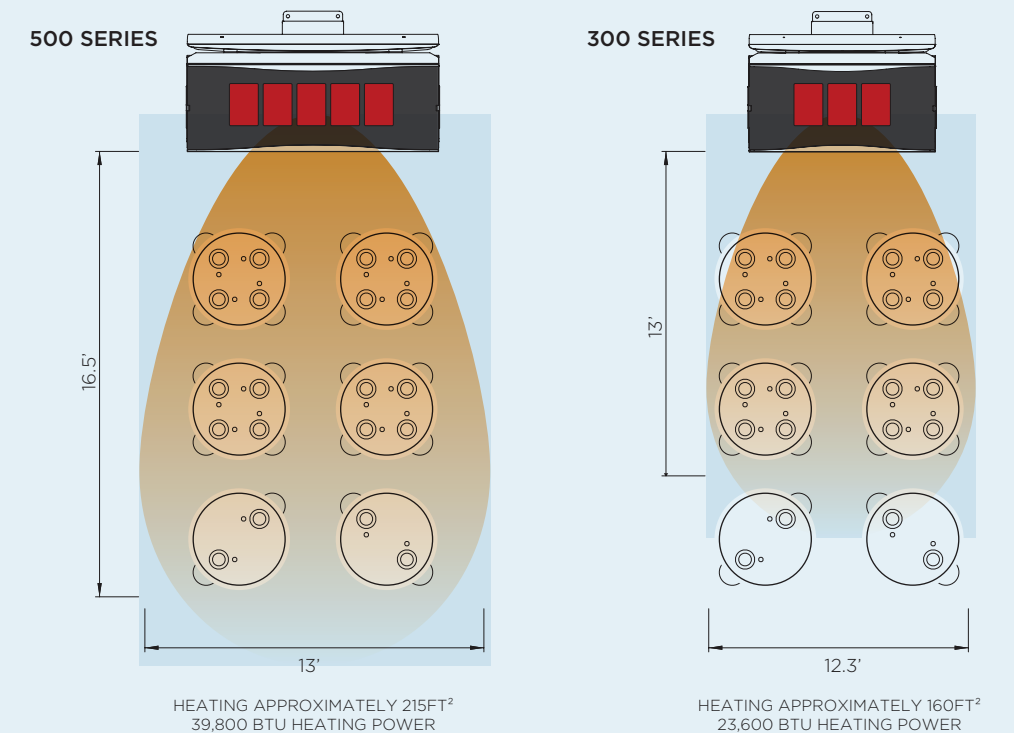

# PLATINUM SMART-HEAT™ ELECTRIC

MODEL NUMBER	2300W SERIES	3400W SERIES
PRODUCT CODES PLATINUM ELECTRIC	BH0320003   BH0320007 BH0320019   BH0320020	BH0320005   BH0320008 BH0320021   BH0320022
PRODUCT CODES PLATINUM ELECTRIC MARINE	BH0320015   BH0320017 BH0320023   BH0320024	BH0320016   BH0320018 BH0320025   BH0320026
FUEL TYPE	ELECTRIC	ELECTRIC
COLOR	BLACK   WHITE	BLACK   WHITE
HEAT AREA	65FT <sup>2</sup>	108FT <sup>2</sup>
RATED CURRENT **	220 - 240V/9.6A 208V/11.1A	220 - 240V/14.2A 208V/16.3A
MINIMUM FLOOR CLEARANCE	WALL 72"   CEILING 96"	WALL 72"   CEILING 96"
<b>MOUNTING OPTIONS</b>		
CEILING MOUNT	✓	✓
CEILING RECESS KIT PRODUCT CODES	BH3130017	BH3130027
WALL MOUNT	✓	✓
RECESSED   FLUSH MOUNT	✓	✓
CEILING POLE MOUNT	✓	✓
CEILING POLE (2') PRODUCT CODE	BH3130023	BH3130023
CEILING POLE (4') PRODUCT CODE	BH3130024	BH3130024
FREESTANDING	-	-
<b>CONTROL OPTIONS</b>		
ON   OFF	✓	✓
ON   OFF PRODUCT CODE	BH3130010-1	BH3130010-1
DIMMER	✓	✓
DIMMER PRODUCT CODE	BH3130011-1	BH3130011-1
MASTER REMOTE *	✓	✓
MASTER PRODUCT CODE	BH3130012-1	BH3130012-1

Measurements displayed within this document are for reference only, for complete requirements see the installation/user manual. Broic takes no responsibility for incorrect or non-compliant installations. All measurement in this document are displayed in inches.  
 \* Control up to six zones of heaters with unlimited heaters per zone from a single remote control. Dimmer control required. Works with dimming controllers. Remote control operates within 100ft of heaters. \*\* Available in 208V and 220-240V configurations.

## PRODUCT MEASUREMENTS

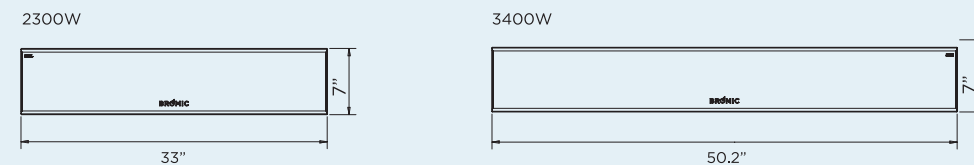

## CEILING RECESS KIT

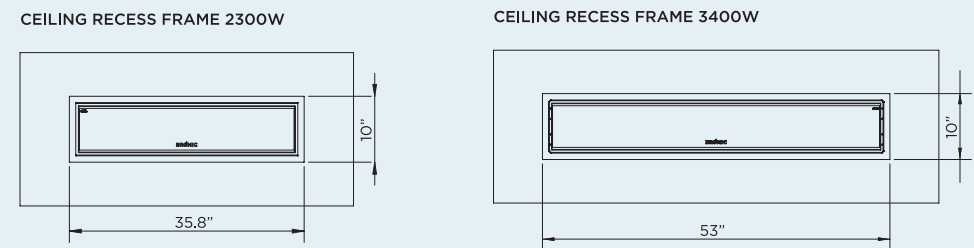

## CEILING CAVITY GUIDE

MINIMUM CAVITY SIZE FOR BOTH 2300W & 3400W MODELS

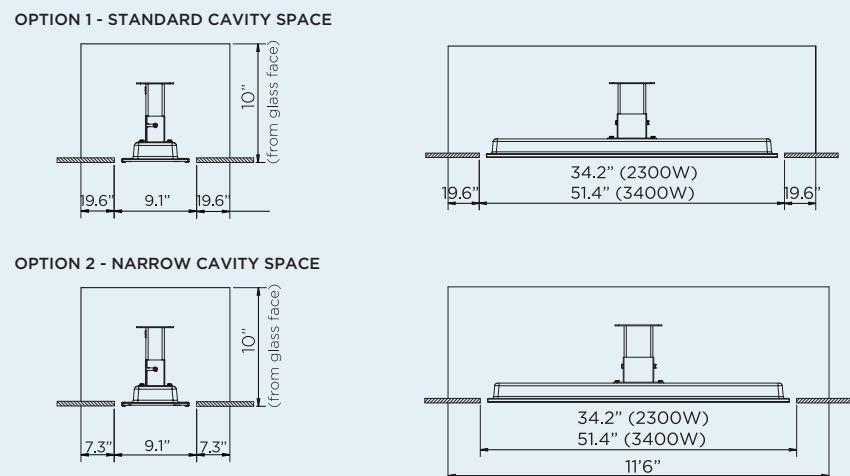

## CEILING & WALL MOUNT CLEARANCE

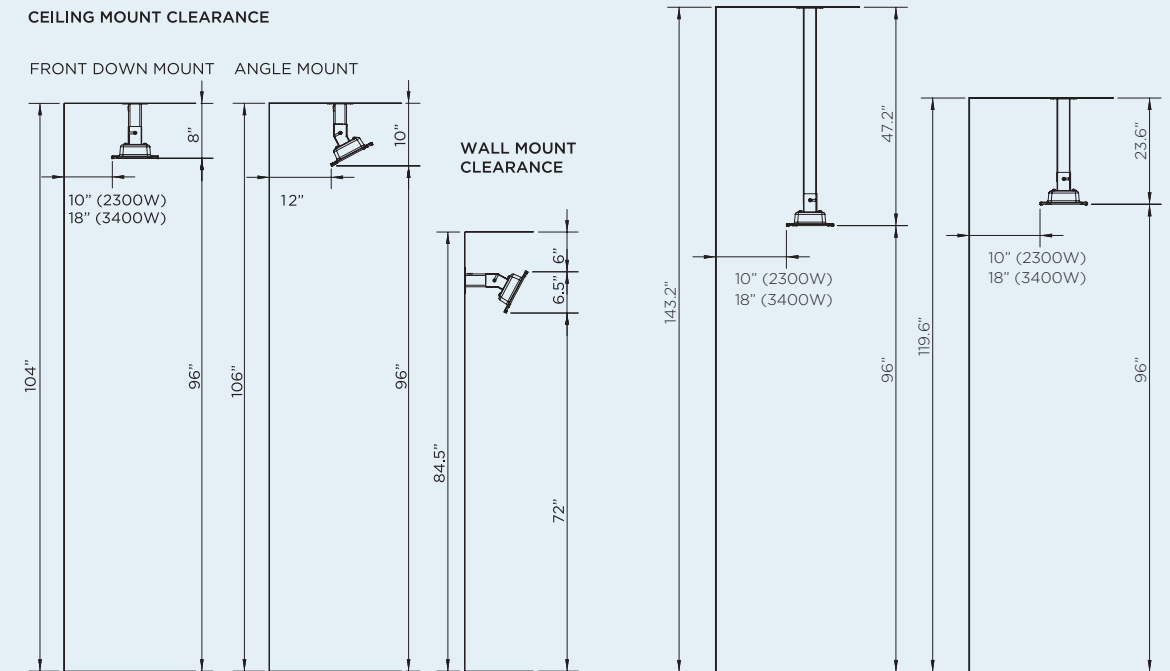

## WALL BRACKET (INCLUDED)

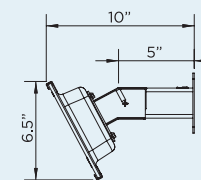

## CEILING BRACKET (INCLUDED)

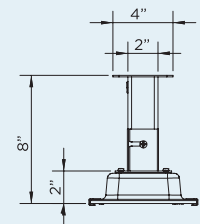

## HEAT AREA

**2300W SERIES**  
HEATING APPROXIMATELY 65FT<sup>2</sup>  
2300W HEATING POWER

**3400W SERIES**  
HEATING APPROXIMATELY 108FT<sup>2</sup>  
3400W HEATING POWER

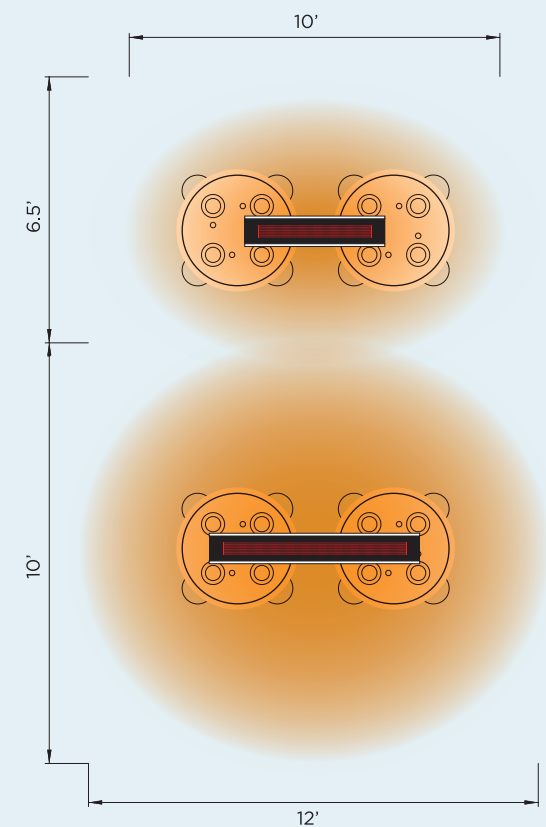

# TUNGSTEN SMART-HEAT™ GAS

MODEL NUMBER	300 SERIES	500 SERIES
PRODUCT CODE	BH0210002-1   BH0210001-1	BH0210004-1   BH0210003-1
FUEL TYPE	LPG   NG	LPG   NG
COLOR	BLACK	BLACK
HEAT AREA	160FT <sup>2</sup>	215FT <sup>2</sup>
ELECTRICAL CONNECTION	110V/2A	110V/2A
MINIMUM FLOOR CLEARANCE	96"	96"
OUTPUT	26,000 BTU	43,000 BTU

## MOUNTING OPTIONS

CEILING MOUNT	✓	✓
WALL MOUNT	✓	✓
RECESSED   FLUSH MOUNT	-	-
CEILING POLE MOUNT	✓	✓
FREESTANDING	-	-

## CONTROL OPTIONS

ON   OFF	✓	✓
ON   OFF PRODUCT CODE	BH3130010-1	BH3130010-1
DIMMER	-	-
MASTER REMOTE	-	-

Measurements displayed within this catalog are minimum requirements for installation. Bromic takes no responsibility for incorrect or non-compliant installations. All measurements in this catalogue are displayed in inches.

## PRODUCT MEASUREMENTS

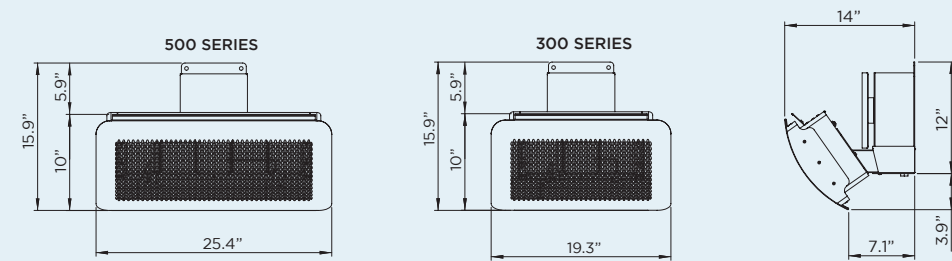

## PRODUCT MEASUREMENTS WITH HEAT DEFLECTOR

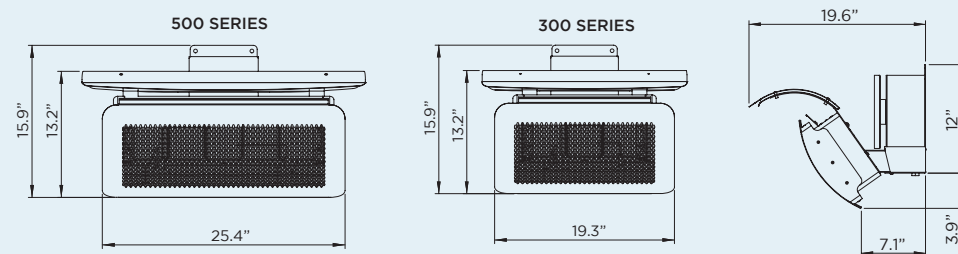

## CEILING & WALL MOUNT CLEARANCE

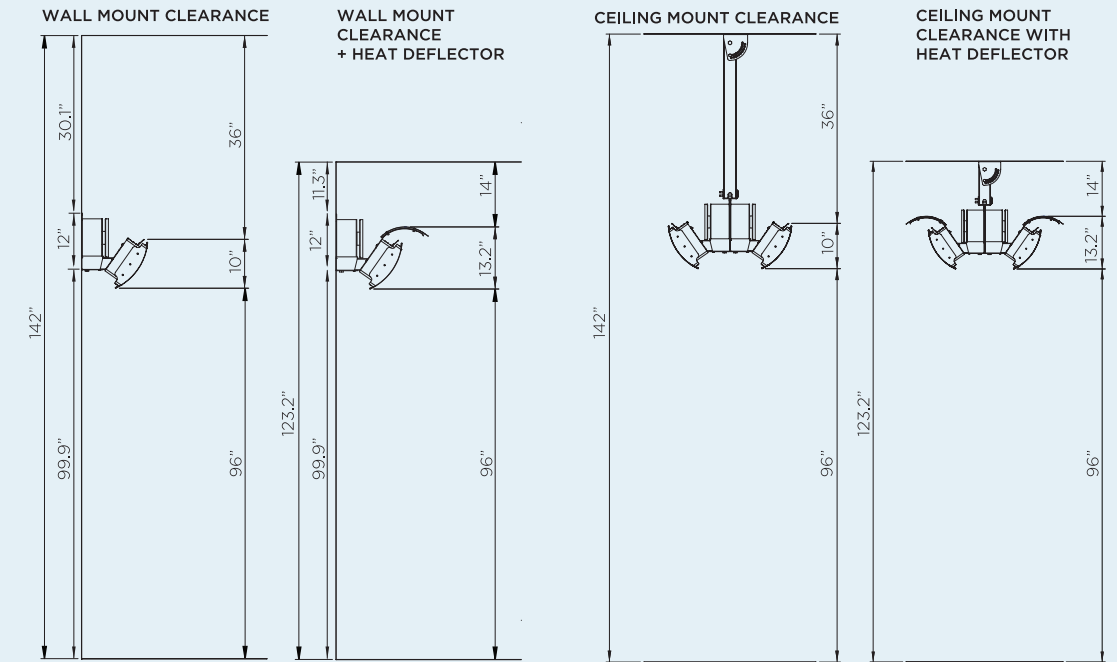

## WALL BRACKET

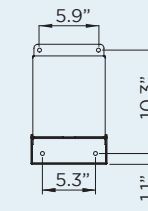

## HEAT AREA

### 500 SERIES

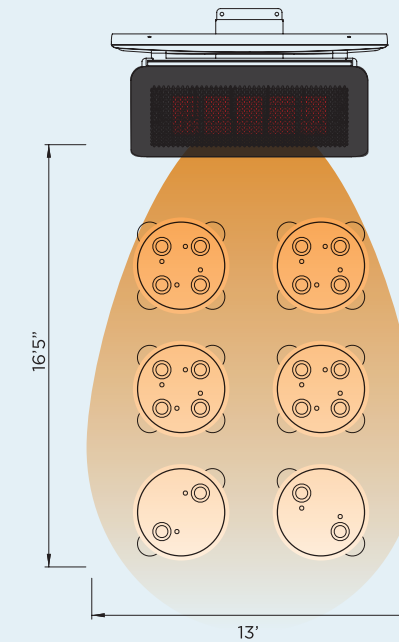

HEATING APPROXIMATELY 215FT<sup>2</sup>  
43,000 BTU HEATING POWER

### 300 SERIES

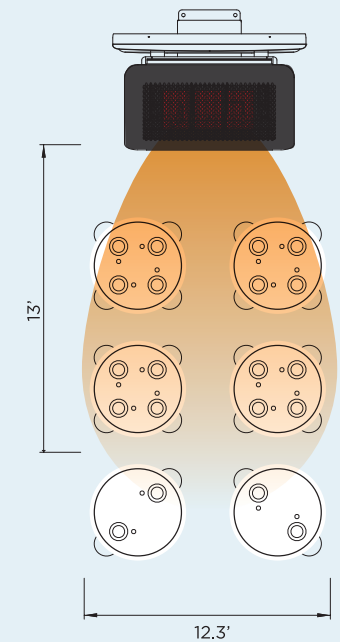

HEATING APPROXIMATELY 160FT<sup>2</sup>  
26,000 BTU HEATING POWER

# TUNGSTEN SMART-HEAT™ ELECTRIC

MODEL NUMBER	2000 SERIES	3000 SERIES	4000 SERIES	6000 SERIES
PRODUCT CODE	BH0420030	BH0420031	BH0420032 BH0420012	BH0420033 BH0420013
FUEL TYPE	ELECTRIC	ELECTRIC	ELECTRIC	ELECTRIC
COLOR	BLACK	BLACK	BLACK   WHITE	BLACK   WHITE
HEAT AREA	65FT <sup>2</sup>	100FT <sup>2</sup>	130FT <sup>2</sup>	160FT <sup>2</sup>
RATED CURRENT **	240V/8.3A 208V/9.62A 277V/7.22A	240V/12.5A 208V/14.42A 277V/10.83A	240V/16.6A 208V/19.23A 277V/14.44A	240V/25A 208V/28.85A 277V/21.66A
MINIMUM FLOOR CLEARANCE	WALL 72"   CEILING 96"		WALL 72"   CEILING 96"	

## MOUNTING OPTIONS

CEILING MOUNT	✓	✓	✓	✓
CEILING RECESS KIT PRODUCT CODES	BH8180010	BH8180011	BH8180010	BH8180011
WALL MOUNT	✓	✓	✓	✓
RECESSED   FLUSH MOUNT	✓	✓	✓	✓
CEILING POLE MOUNT	✓	✓	✓	✓
TUBE SUSPENSION KIT (36") PRODUCT CODE	BH8180012			
FREESTANDING	-	-	-	-

## CONTROL OPTIONS

ON   OFF	✓	✓	✓	✓
ON   OFF PRODUCT CODE	BH3130010-1			
DIMMER	✓	✓	✓	✓
DIMMER PRODUCT CODE	BH3130011-1			
MASTER REMOTE *	✓	✓	✓	✓
MASTER REMOTE PRODUCT CODE	BH3130012			

Measurements displayed within this catalog are minimum requirements for installation. Bromic takes no responsibility for incorrect or non-compliant installations. All measurements in this document are displayed in inches.

\*\* Available in varying voltages: 240V, 208V and 277V

\* Control up to six zones of heaters with unlimited heaters per zone from a single remote control. Dimmer control required. Works with dimming controllers. Remote control operates within 100ft of heaters.

## PRODUCT MEASUREMENTS

2000W & 4000W

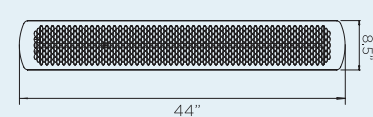

3000W & 6000W

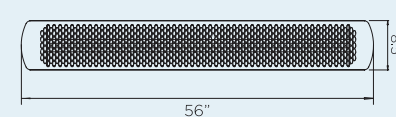

## CEILING RECESS

CEILING RECESS FRAME 2000W & 4000W

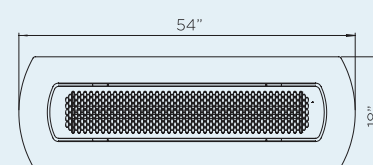

CEILING RECESS FRAME 3000W & 6000W

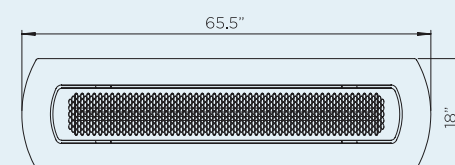

## CEILING RECESS

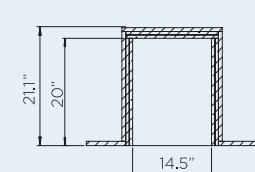

MINIMUM  
CEILING CAVITY

2000W & 4000W

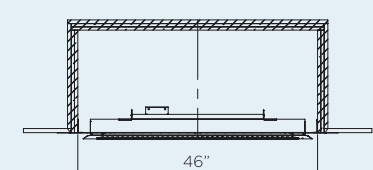

3000W & 6000W

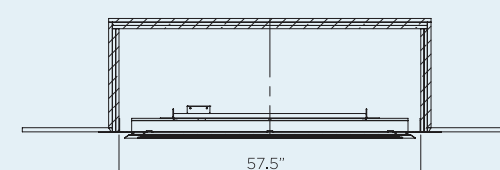

## CEILING & WALL MOUNT CLEARANCE

### CEILING MOUNT CLEARANCE

2000W & 3000W

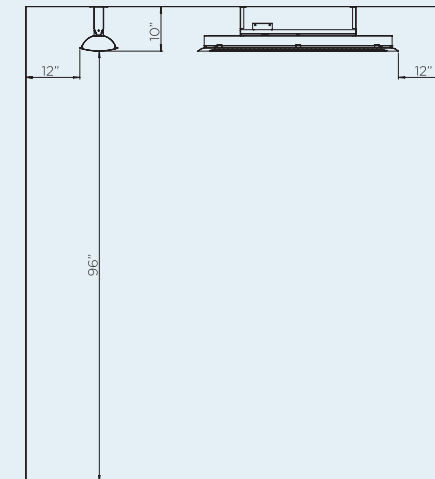

### CEILING MOUNT CLEARANCE

4000W & 6000W

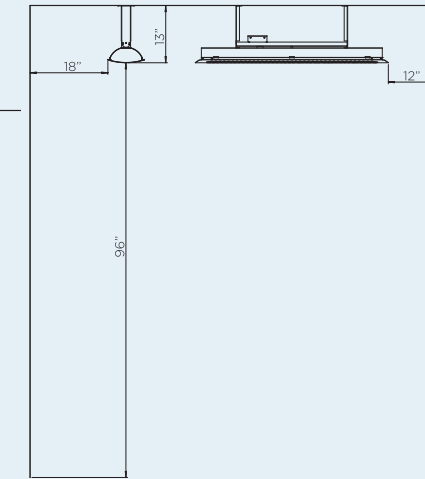

### CEILING POLE CLEARANCE

4000W & 6000W

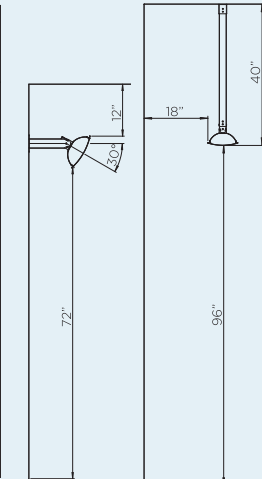

2000W & 3000W

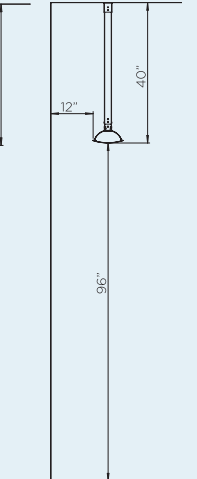

## WALL BRACKET (INCLUDED)

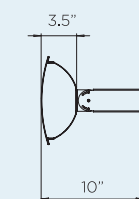

2000W & 3000W

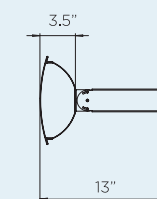

4000W & 6000W

## HEAT AREA

### 2000W SERIES

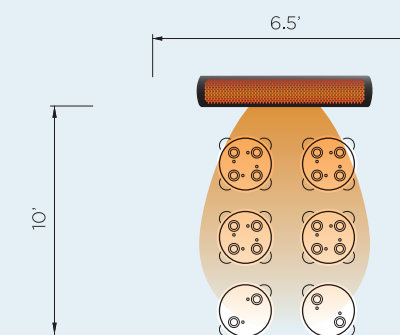

HEATING APPROXIMATELY 65FT<sup>2</sup>  
2KW HEATING POWER

### 3000W SERIES

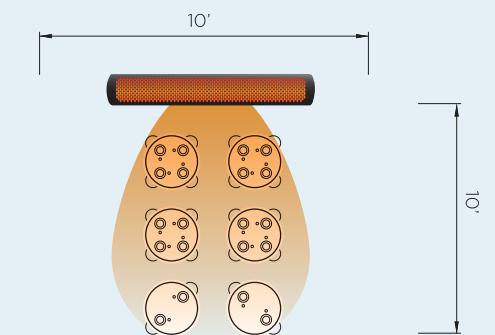

HEATING APPROXIMATELY 100FT<sup>2</sup>  
3KW HEATING POWER

### 4000W SERIES

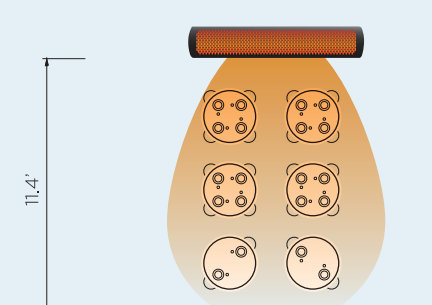

HEATING APPROXIMATELY 130FT<sup>2</sup>  
4KW HEATING POWER

### 6000W SERIES

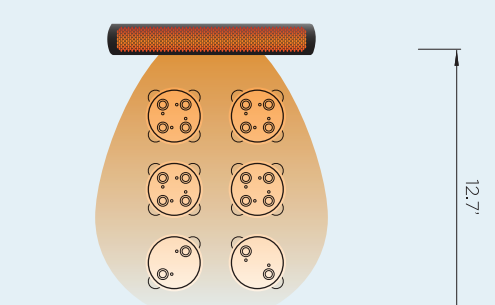

HEATING APPROXIMATELY 160FT<sup>2</sup>  
6KW HEATING POWER

# TUNGSTEN SMART-HEAT™ PORTABLE

## MODEL NUMBER

PRODUCT CODE	BH0510001   BH0510005
FUEL TYPE	LPG   NG
COLOR	BLACK
HEAT AREA	215FT <sup>2</sup>
ELECTRICAL CONNECTION	-
MINIMUM CEILING CLEARANCE	36"
OUTPUT	38,500 BTU

## MOUNTING OPTIONS

CEILING MOUNT	-
WALL MOUNT	-
RECESSED   FLUSH MOUNT	-
CEILING POLE MOUNT	-
FREESTANDING	✓

## CONTROL OPTIONS

ON   OFF	-
DIMMER	-
MASTER REMOTE	-

## ADDITIONAL OPTIONS

HEATER COVER PRODUCT CODE	BH3030010
---------------------------	-----------

Measurements displayed within this catalog are minimum requirements for installation. Bromic takes no responsibility for incorrect or non-compliant installations. All measurements in this catalogue are displayed in inches.

## PRODUCT MEASUREMENTS

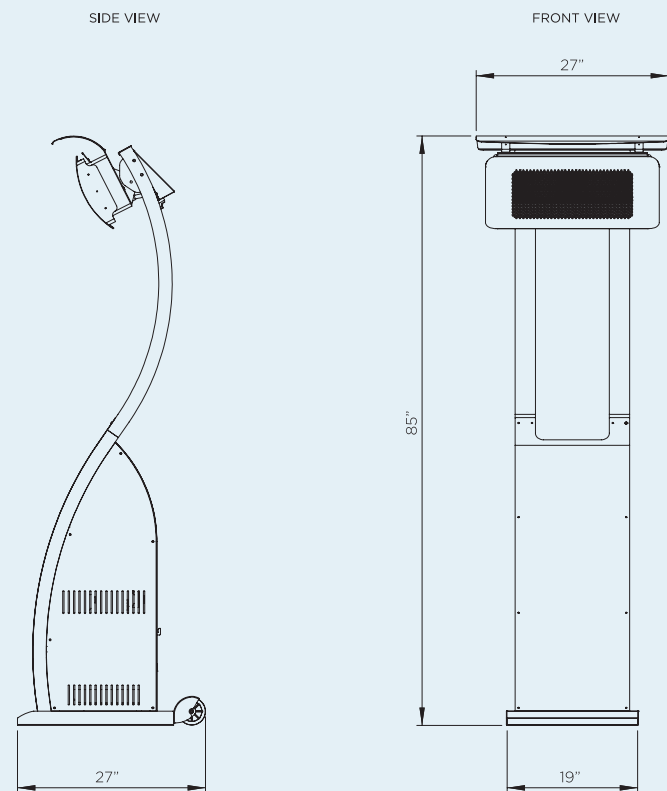

## CEILING & WALL CLEARANCE

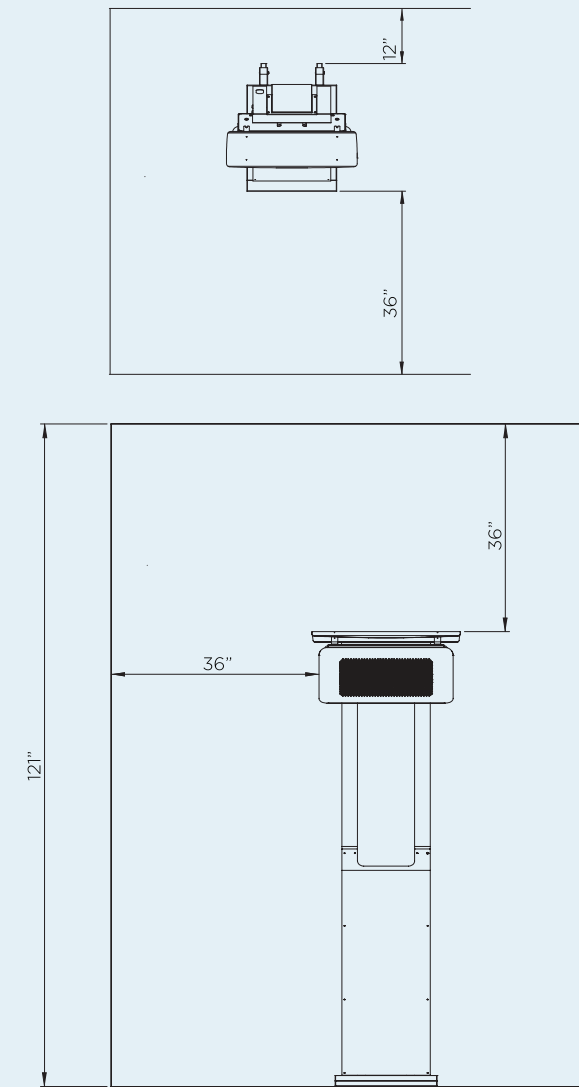

## HEAT AREA

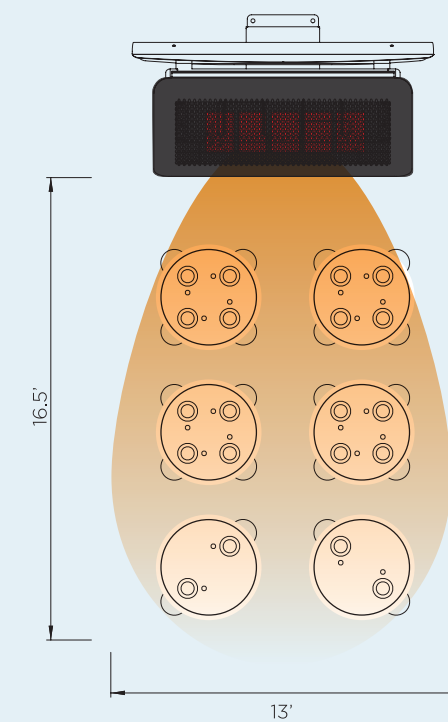

**TUNGSTEN PORTABLE**  
HEATING APPROXIMATELY 215FT<sup>2</sup>  
38,500 BTU HEATING POWER

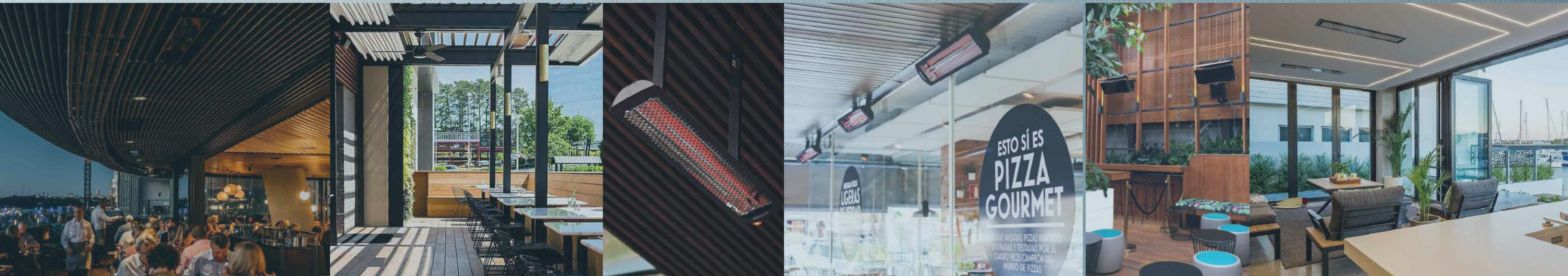

## DESIGN SERVICE

---

As part of our complimentary service, Bromic Heating Specialists will custom design and tailor a solution to best heat your outdoor living and entertainment spaces.





## ABOUT **BROMIC GROUP**

---

Bromic's reputation for industry and innovation reaches back to 1978. Initially a supplier of gas components, Bromic has since grown to become an international leader that designs, manufactures and distributes a diverse range of quality, engineered products on a global scale.